

Product Catalog

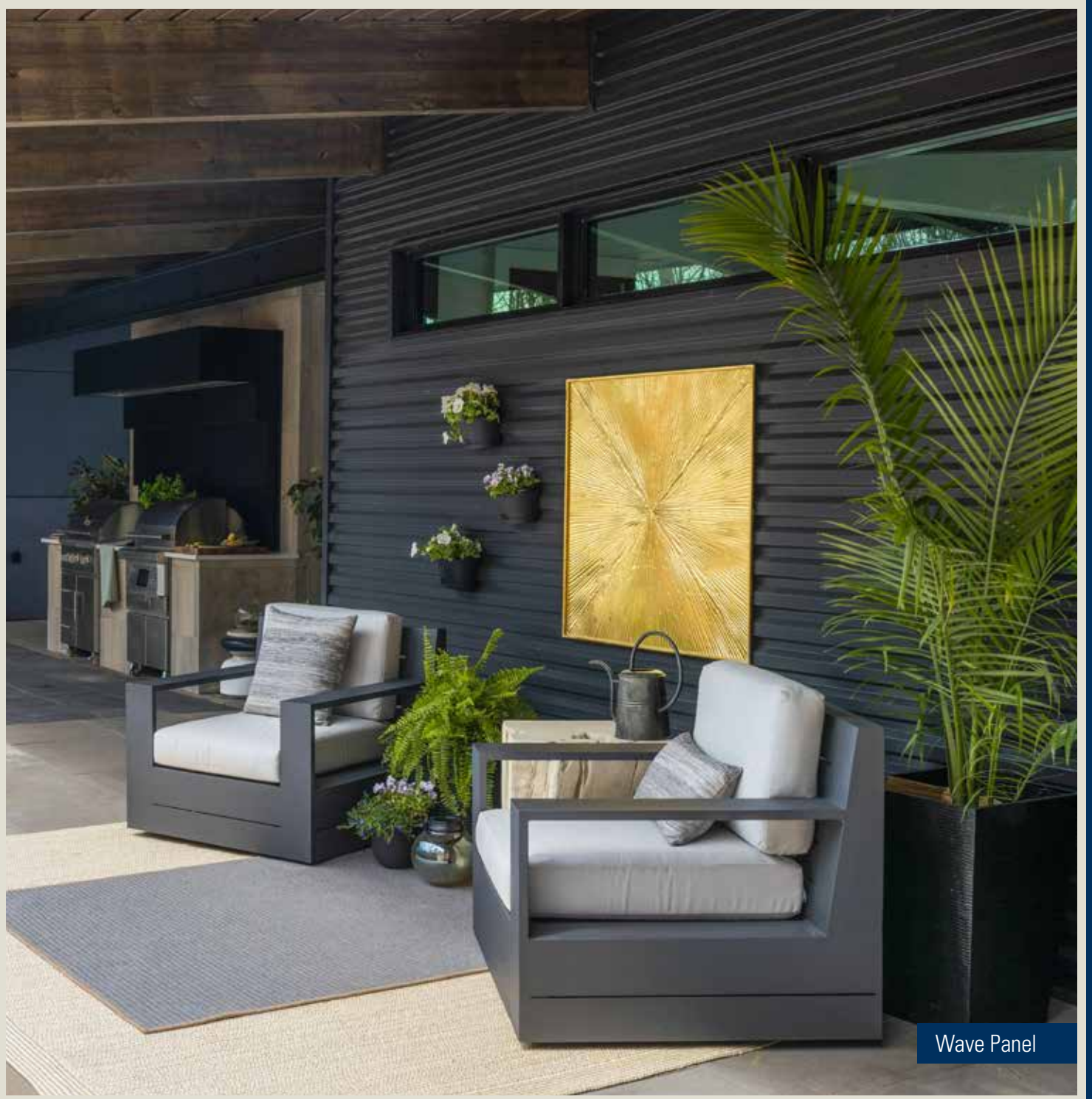

Wave Panel

Table Of Contents



When Thomas McElroy Sr. founded McElroy Metal in 1963, he not only put his name on the building but also instilled a deep commitment to providing the highest-quality products in the industry. Today, as employee-owners, we continue this tradition by taking immense pride in every relationship we cultivate and every order we meticulously produce, package, and deliver.



Our product offering boasts over 30 different roof and wall profiles, including standing seam panels for straight, tapered, and curved systems, insulated panels, a wide range of standard and custom trims, color-matched soffits, slit coil, substructural components, and cold-formed buildings. This comprehensive selection positions us as one of the industry leaders in terms of product diversity.

With 87 locations nationwide, we are well-equipped to serve you and your customers with the quality products and services that have become synonymous with the McElroy Metal name. We understand that you have numerous choices when it comes to your metal components, and as employee-owners, we are genuinely grateful for the opportunity to not only earn but also retain your business.

New Products	MasterLok-90 Roof 17	Mesa Roof & Wall 25
Nostalgia Board & Batten Wall 1 & 21	MasterLok-FS Roof 17	5V Roof & Wall 25
Trap-Tee. Roof 1		U-Panel Roof & Wall 25
Standing Seam Recover Systems	Soffit / Fascia & Canopy	R-Panel Roof & Wall 27
138T & 238T Recover Roof 2	FW Series Soffit. 18	Multi-Rib Roof & Wall 27
Retrofit & Roof Hugger. Roof 3	MCP Canopy 18	Mini-Rib Wall, Fascia, Liner . . . 27
Cold Formed Buildings Buildings. 4	Matrix Soffit. 19	Multi-V Wall. 27
	Marquee-Lok Soffit/Fascia/Wall. . 19	
Substructural Components 5	Concealed Fastener Panels	Metal Shingles and Tile
	Wave Wall 20	Tilcor CF Shingle Roof. 28
Standing Seam Systems	Visionline Wall 21	Met-Tile Roof. 29
Maxima Roof 6	Nostalgia Board & Batten Wall 1 & 21	Milan Roof. 29
138T & 238T Panel Roof & Wall . . . 9	MSR Wall 21	Solar Solutions 30
Medallion-Lok Roof & Wall . . 11		
Medallion I Roof & Wall . . 13	Exposed Fastener	Green Span Profiles
Medallion II Roof & Wall . . 13	Mega-Rib Roof & Wall 23	Insulated Metal Panels Roof & Wall inside back cover
Meridian Roof & Wall . . 15	Multi-Cor & M-Cor Roof & Wall 23	
Instaloc Roof & Wall . . 16	Max-Rib Roof & Wall 24	Slit Coil and Flat Sheets. Roof & Wall back cover
Mirage II Roof 16	Modern-Rib Roof & Wall 25	

New Products



Nostalgia Board & Batten

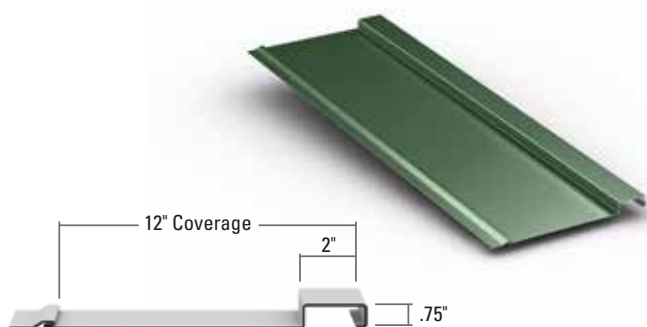

- Minimal maintenance compared to wood siding
- 12" coverage width
- Wall panel application installs over solid deck
- Concealed fastened attachment through pre-punched fastening flange
- Pan condition: flat

Nostalgia- Details

- **Applications**
Wall panel.
- **Substrates**
Plywood or OSB.
- **Material**
Standard - 24 GA. ASTM A792 (50 ksi steel)
AZ55 - Bare
AZ50 - Painted
- **Manufacturing**
Roll-formed in factory.
- **Finishes**
Acrylic Coated Galvalume®
Fluoropolymer (Kynar 500® PVDF)

- **Pan Conditions**
Flat Pan
Oil canning is inherent in all metal panels and is not cause for panel rejection.

Testing Data

- For any available Test Data, Section Properties or Load Tables, please visit our download section at www.mcelroymetal.com



Trap-Tee

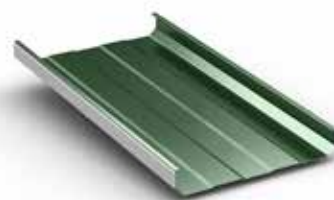

- 2 3/4" tall mechanically seamed symmetrical semi-trapezoidal panel
- 1/4:12 minimum roof slope
- Installs over open framing or solid deck
- Best suited for simple sloped roofs without dormers, hips, valleys or other special conditions
- Single-piece panels up to 250' long
- No lap conditions = Improved weathertightness
- Individual panel replaceability
- Watertight seam design
- Bi-directional seamer
- Seam cap has 2 beads of continuous factory applied sealant

Trap-Tee Details

- **Applications**
Roof panel.
- **Substrates**
Plywood, metal deck, rigid insulation/metal deck or open framing.
- **Material**
Standard - 24 GA. ASTM A792 (50 ksi steel)
AZ55 - Bare,
AZ50 - Painted Optional - 22 GA. ASTM A792
AZ50 - Painted - 20 GA. ASTM A792
AZ55 - Bare, AZ50 - Painted
- **Manufacturing**
Site formed – 18" and 24" panel. Factory formed – 18" Panel only (Houston plant only) Max length 40'-0".
- **Finishes**
Acrylic Coated Galvalume®
Fluoropolymer (Kynar 500® PVDF)
- **Pan Conditions**
3" wide minor ribs. Oil canning is inherent in all metal panels and is not cause for panel rejection.

Testing Data

- For any available Test Data, Section Properties or Load Tables, please visit our download section at www.mcelroymetal.com

Standing Seam Retrofit Recover Systems



138T Shingle Recover System

Featuring McElroy's 138T symmetrical standing seam panel, this innovative system installs directly over existing shingles without tear-off or underlayment.

- Ease of installation
- Above sheathing ventilation (ASV) - Utilizing air space to help reduce heat transfer and decrease energy expense)
- No tear off/disposal of existing roof
- No underlayment required
- Individual panel replaceability
- Decades long service life

8" shingle recover clip with ASV



The key to proper installation of standing seam recover over shingles is the patented shingle recover clip, which is long enough to sit on two shingles simultaneously

238T Metal-Over-Metal System

McElroy Metal's patented 238T frameless metal-over-metal recover solutions provide low cost retrofit solutions over both existing exposed fastened and 3" tall trapezoidal standing seam systems.

- Two patented frameless recover systems
- Job site production enables eave to ridge panels
- Extremely high wind uplift capacity without additional edge zone or corner framing
- 24" wide panels reduce installation labor
- Individual panel removal and replacement
- Decades long service life

Seaming

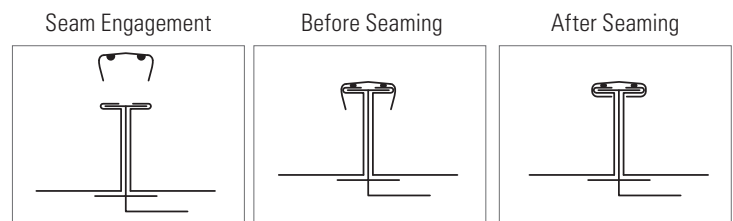

Single length panels offer labor savings and improve weathertightness.

Trap-Tee

For more details about Trap-Tee, see page 1.

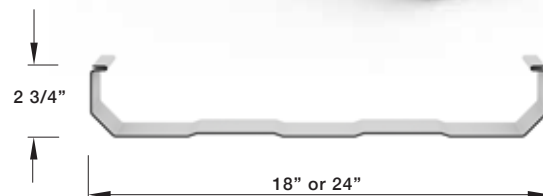
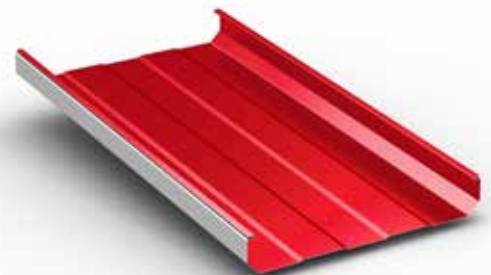

McElroy Metal has the optimal solution for building owners, architects, and contractors who desire a high-performance, long-term solution for worn-out conventional roofs. McElroy Metal Retrofit Roofing Systems provides an extended service life and reduced life-cycle costs. In many cases, the cost difference between a conventional roof tear-off and replacement compared to a retrofit metal roof system is a return on investment that can be recovered in a short period of time.

Adaptation to Steel

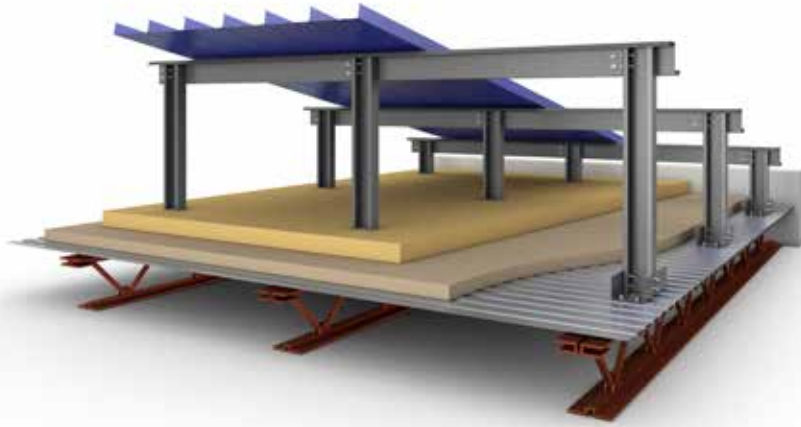

Roof Hugger

- Leak free
- Cost-efficient
- Energy saver
- Long lasting
- Custom-fit
- High-strength material
- Minimal assembly height
- Enhanced roof strength
- Accommodates extra insulation
- Special sizes available

Retrofit Systems

Building Owner Benefits

- Decades-long service life
- Reduced maintenance
- Energy savings through reduced consumption
- Increases wind and snow storm resistance
- Possible reduction of insurance premiums
- Improves appreciable value of your building

The Contractor's Advantages

- Easy to erect framing system
- Designed by in-house McElroy Metal engineering staff
- Proven and tested standing seam metal roofing systems
- All materials manufactured by McElroy Metal



Cold Formed Buildings



**EASYFRAME
METAL BUILDINGS**
Quality • Service • Performance

It's not often that a new product creates real change in an industry, but our EasyFrame Metal Buildings have done just that! Progressive contractors and building owners in the United States are quickly learning what the Australians have known for decades... Cold Formed Buildings can be a great economical option to traditional pre-engineered metal buildings (PEMB's). And, since each building ships with stamped engineering for both building and foundation, you can feel confident that you're always buying a quality product.



Saves Time

- **Shorter Lead Times:** Pre-engineered building lead-time often runs several months. In contrast, you can get our EasyFrame Metal Buildings delivered within weeks!
- **Quicker Installation:** For contractors, time is money! With our EasyFrame Metal Buildings your crews can quickly complete a project and move on to the next one. And, from our experience, building owners rarely complain about a quick construction and move-in schedule.
- **Reduced Onsite Fabrication:** our EasyFrame Metal Buildings are constructed with weld-free roll formed components. Not only do they look better than traditional PEMB's, they also require minimal jobsite fabrication.

Saves Money

- **20-25% Less Concrete:** Our EasyFrame Metal Buildings utilize closer column spacing than PEMB's. As a result, footing and anchor bolts can be omitted saving substantial concrete cost and labor.
- **No Pre-Set Anchor Bolts!** Cold Formed Buildings save time and money by utilizing continuous footing and slab pours which means there is no requirement for the large heavy foundation/pads seen on PEMB's.
- **Lower Equipment Fees:** Due to the weight of the main columns, traditional PEMB's typically require a crane for installation. However, a Cold Formed Building installation is often completed with just scaffolding or a forklift. Between equipment rental and operator fees, the savings add up.

Substructural Components



Substructural Components

McElroy's substructural components represent the broadest selection of cold-formed substructural components in the industry. McElroy's new Substructural XL line adds capabilities down to 10 gauge and up to 24" web widths.

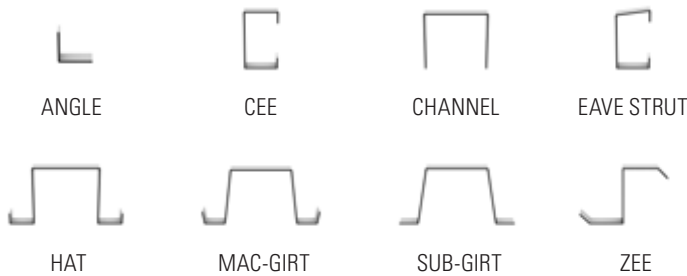

Product Offering

- Standard Cee & Zee members available in 4-12" webs; 12, 14 & 16 gauge
- Substructural XL products include 10, 12, 14 & 16 gauge thickness with webs up to 24" deep.
- Hat Channel, Mac-Girt & Sub-Girt offered in 16, 18 & 20 gauge
- Zee shapes manufactured with non-symmetrical flanges for installation ease
- Standard & custom punching available
- Red oxide is standard for most McElroy manufacturing facilities. Galvanized (G-90) is also available for popular sizes and is the standard finish in Adelanto, California.

Substructural XL

McElroy Metal's Substructural XL wide web components set a new industry standard, offering significant labor and lead-time savings.

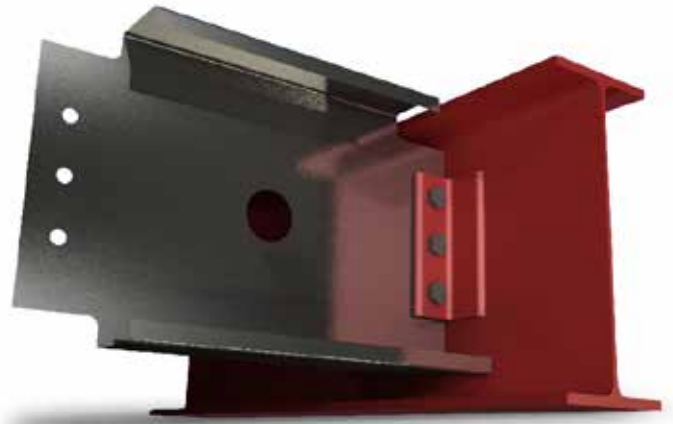

Benefits

- Highly flexible punching capabilities reduce costly field drilling
- Taller web heights offer greater yield carrying ability
- Factory flange notching reduces costly secondary fabrication and/or field torching and cutting
- Much quicker lead time than competing products
- Single manufacturer process removes time lag and possible mistakes at custom fab shops
- Easy installation saves time and labor costs

Standing Seam Systems



Walter Elisha Park
Maxima 1.5

Maxima

Offering strength, durability and aesthetics, vertical leg standing seam systems are the industry's most popular roofing panel. To meet the varying needs of specifiers and contractors, McElroy Metal's Maxima line represents the industry's broadest selection of vertical leg systems:

- Seam heights of 1.5", 2" & 3"
- Varying pan widths
- 90° & 180° seams
- Available flat or curved

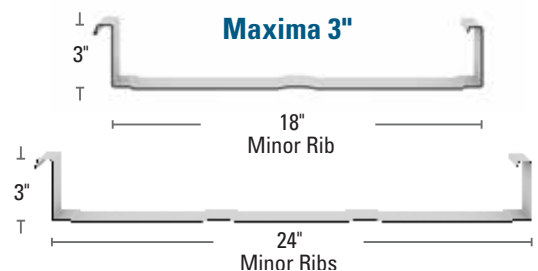
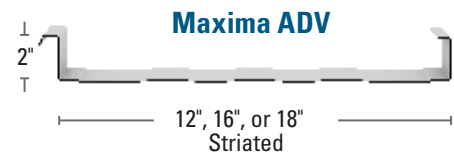
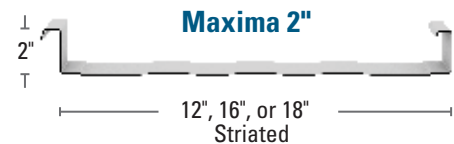
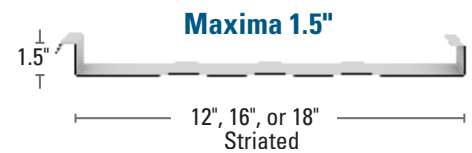
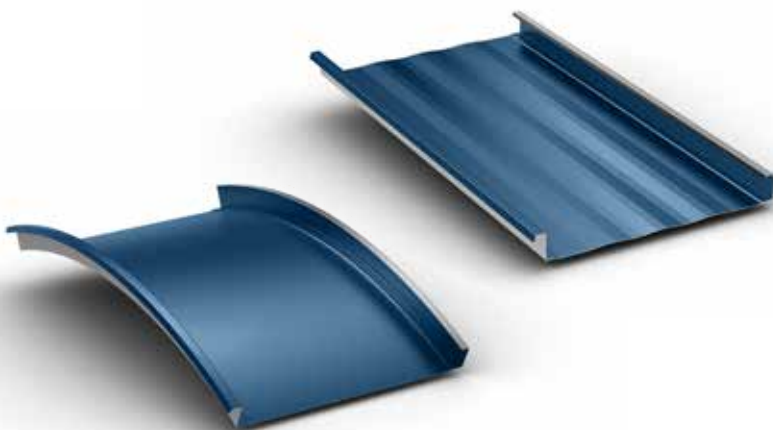

Note: Maxima ADV also available without shoulders. Maxima 2" and 3" panels feature a return leg on both the male and female seams. These return legs help create greater strength and uplift capabilities. Maxima 1.5 and ADV do not feature the return legs, which enables the panels to be curved as well as seamed to 180 degrees.

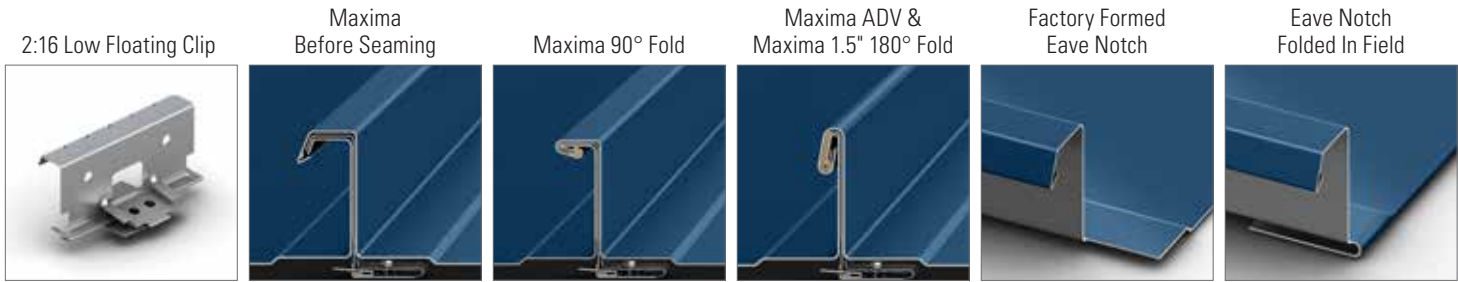

Note: Patented Floating Clips allow for 3 1/8" of thermal movement

MAXIMA PROFILES	WIDTH	PAN CONDITIONS					FACTORY NOTCHING			SEAM		
	WIDTH IN INCHES	STRIATED	MINOR RIBS	SINGLE PENCIL RIB	DOUBLE PENCIL RIB	FLAT PAN	CURVED	LAP	EAVE	NONE	90 DEGREE SEAM	180 DEGREE SEAM
Maxima 1.5"	12	■		■		■	■			■		■
Maxima 1.5"	16, 18	■			■	■	■			■		■
Maxima 2"	12	■		■		■		■	■	■	■	
Maxima 2"	16, 18	■			■	■		■	■	■	■	
Maxima ADV 2"	12	■		■		■		■	■	■		■
Maxima ADV 2"	16, 18	■			■	■		■	■	■		■
Maxima 3" Minor Rib (Std.) 18" panel only available with one minor rib	18, 24	■	■					■	■	■	■	

Striated panels are recommended as they reduce the appearance of oil canning.

Curving Details

- Only Maxima 1.5 and Maxima ADV can be curved
- Minimum radius: 25' for 2" ADV, 12' for 1.5"
- 180° seam required
- Sealant to be field applied on curved applications
- Maxima ADV and Maxima 1.5 flat panels will curve naturally on a radius of 250 feet or greater

Details

- Mechanically seamed profile
- Factory formed eave notch upon request
- Factory applied sealant (on non-curved panels only)
- Minimum slope: 1:12 for 1.5"
- Minimum slope: 1/2:12 for 2"
- Minimum slope: 1/4:12 for 3"
- Can be installed over solid deck or open framing

- Maxima 2" and ADV also available jobsite formed for long lengths
- Floating clips allow for 3 1/8" thermal movement

Panel Options

- Panel height & width: See panel profile drawings above
- Panel configurations: See chart on left
- Coating: Kynar 500® (PVDF)

- Substrate:
 - Standard 24 gauge Galvalume®
 - Optional 22 gauge Galvalume
 - .032 and .040 aluminum (Aluminum is produced at the Sunnyvale, TX facility only. No testing available on aluminium)

Testing Data

- For any available Test Data, Section Properties or Load Tables, please visit our download section at www.mcelroymetal.com

Oil canning (pan wave) is a natural occurrence in metal panels and is not a cause for panel rejection.



Roma High School
138T & 238T



Villa Rica Library
138T



Georgetown Fire Department
138T

138T & 238T

138T & 238T symmetrical standing seam systems offer many advantages over popular asymmetrical panels. 138T and 238T panels do not have male and female seams. Rather, these panels have identical left and right seams. Panels are then joined with a mechanically seamed cap.

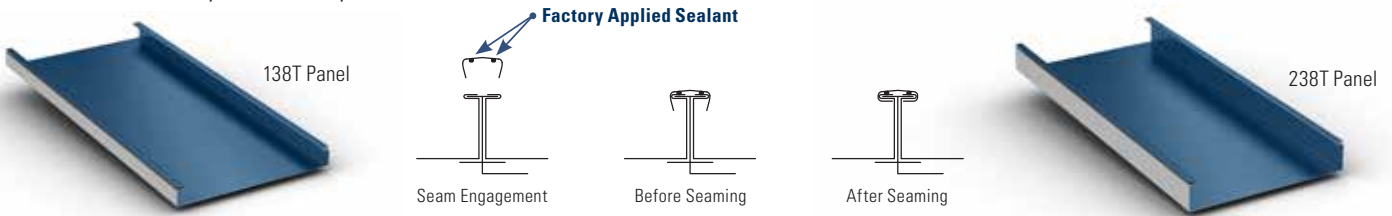

138T Panel Options

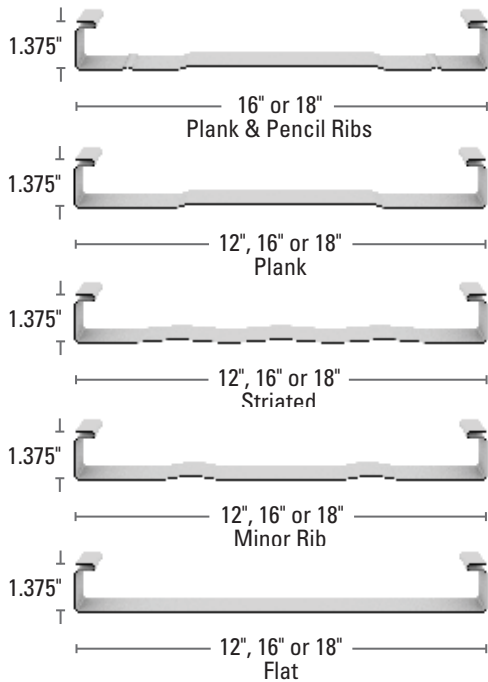

- Ease of installation
- Available flat, curved, and tapered
- Individual panel replacement
- Watertight seam design
- Can be jobsite formed for longer lengths
- No laps equals greater watertightness

238T Panel Options

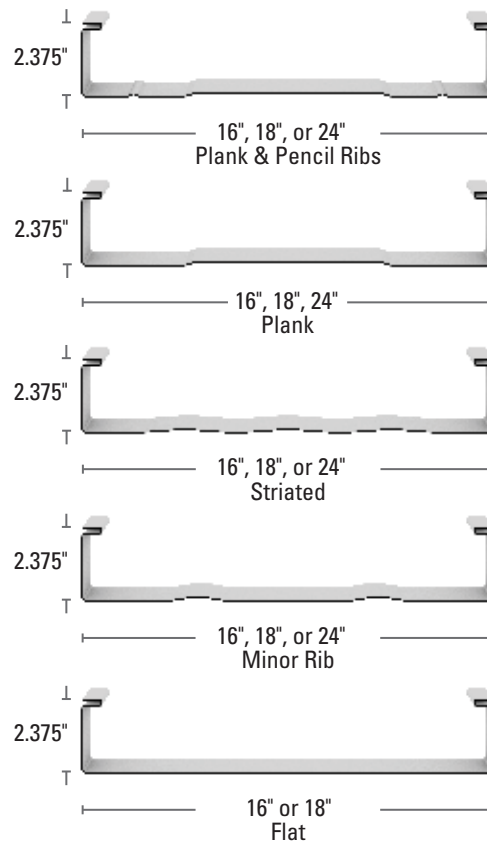

138T Clip



238T Clip



138T and 238T Two Piece Multi-Span Clip (238T Shown)



138T and 238T Two Piece Multi-Span Clip as Installed (238T Shown)



138T Details

- Mechanically seamed
- Minimum slope: 1:12
- Must be installed over solid deck

Testing Data

- For any available Test Data, Section Properties or Load Tables, please visit our download section at www.mcelroymetal.com

Panel Options

- 138T panel width: 12", 16", 18"

Panel configurations:

- 138T (16" & 18"): flat, striated, plank & pencil ribs, plank, minor ribs (plank & pencil rib recommended)
- 138T (12"): flat, striated, minor ribs, plank (plank recommended)

Coating: Kynar 500® (PVDF)

Substrate:

- Standard 24 gauge Galvalume®
- Optional 22 gauge Galvalume
- .032 and .040 aluminum
- Optional 16 oz and 20 oz copper (Houston plant only)

- 138T manufacturing: factory, jobsite roll-formed, curved on-site

238T Details

- Mechanically seamed
- Minimum slope: 1/2:12
- 238T subject to prior approval, 1/4:12 may be acceptable
- Can be installed over solid deck or open framing

Testing Data

- For any available Test Data, Section Properties or Load Tables, please visit our download section at www.mcelroymetal.com

Panel Options

- 238T panel width: 16", 18", 24" (24" panel formed on-site only)
- Panel configurations: 238T: flat (16" & 18" only), striated, plank & pencil ribs, plank, minor ribs (plank & pencil ribs recommended)
- Coating: Kynar 500® (PVDF)
- Substrate:
 - Standard 24 gauge Galvalume®
 - Optional 22 gauge Galvalume
 - .032 and .040 aluminum
 - Optional 16 oz and 20 oz copper (Houston plant only)
- 238T manufacturing: factory, jobsite roll-formed, curved on-site



Residence
Medallion-Lok



Charles Smith & Sons Funeral Home
Medallion-Lok



Wind Creek Casino & Resort
Medallion-Lok

Medallion-Lok

Medallion-Lok is a snap-together architectural panel with structural capabilities that features a rigid 1.75" standing seam. Medallion-Lok is McElroy Metal's most popular snap-together panel and has been utilized to add beauty and function on projects all across the country.

Panel Options

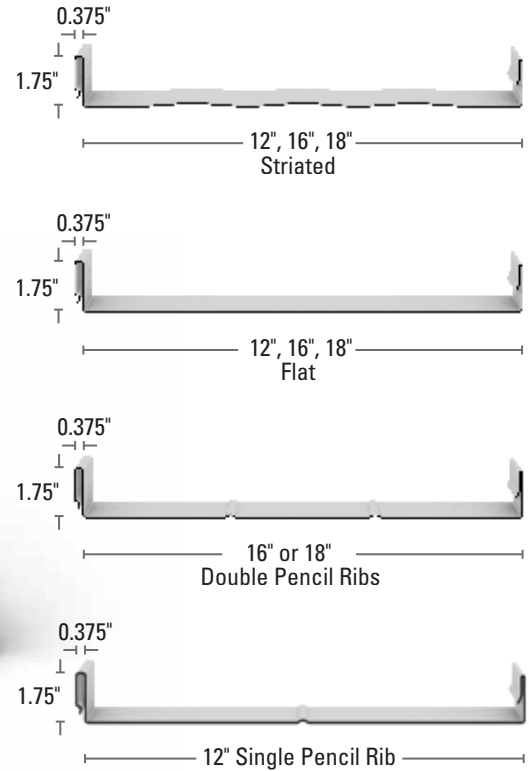

Note: Striated panels are recommended as they reduce the appearance of oil canning



Standard Clip

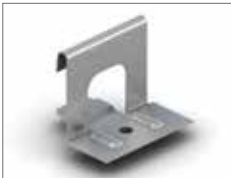

UL 90 Clip



Seam Detail



Factory Eave Notch

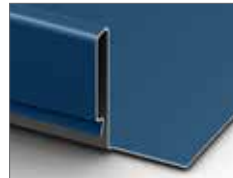

Eave Notch
Folded In Field



Details

- Factory formed eave notch upon request in: Clinton, Peachtree City, and Sunnyvale
- Factory applied sealant
- Minimum slope: 3:12
- Can be installed over solid deck or open framing

Panel Options

- Panel width 12", 16" & 18"
- Panel configurations: striated, ribbed or flat pan (striated recommended)
- Coating: Kynar 500® (PVDF)
- Substrate:
 - Standard 24 gauge Galvalume®
 - Optional 22 gauge Galvalume
 - .032 aluminum

Testing Data

- For any available Test Data, Section Properties or Load Tables, please visit our download section at www.mcelroymetal.com

Learning Center
Medallion I Curved



Commercial Property
Medallion II

Medallion I

Medallion I is an architectural standing seam system featuring a narrow batten cap applied over roofing panels and concealed clips. Medallion I is installed over solid deck and can also be curved to meet radius panel specifications.

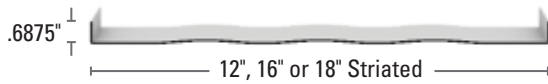

Medallion II

Medallion II is an architectural standing seam system that features a 1 1/2" wide batten cap applied over roofing panels and concealed clips. Medallion II is installed over solid deck.

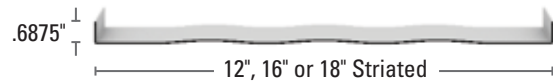

*Cover width is pan width plus 1"

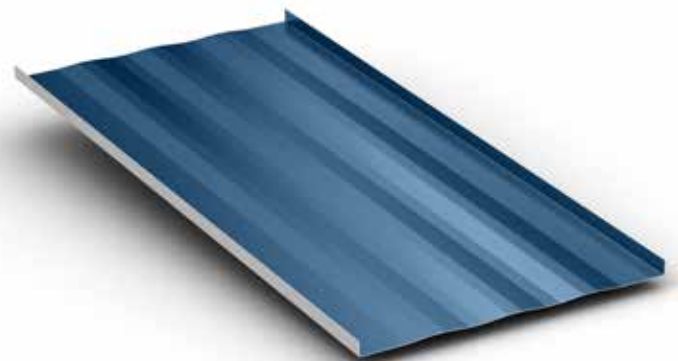
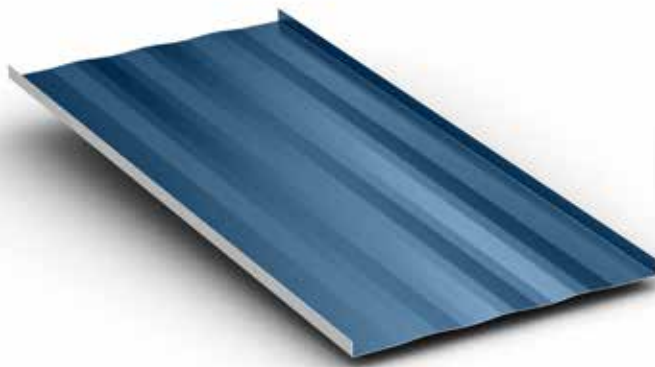

Medallion I Batten

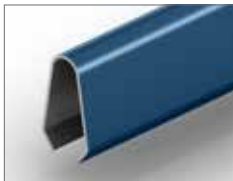

Medallion I Clip

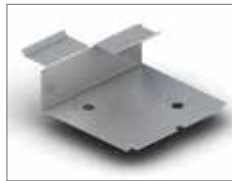

Medallion II Batten



Medallion II Clip



Details

- Minimum slope: 3:12
- Must be installed over solid deck

Curving Details

- Minimum radius: 30"

Panel Options

- Panel width: 12", 16" and 18"
- Panel configurations: striated (recommended), ribbed, or flat pan
- Coating: Kynar 500® (PVDF)
- Substrate:
 - Standard 24 gauge Galvalume®

Testing Data

- For any available Test Data, Section Properties or Load Tables, please visit our download section at www.mcelroymetal.com

Details

- Minimum slope: 3:12
- Must be installed over solid deck

Panel Options

- Panel width: 12", 16" and 18"
- Panel configurations: striated (recommended), ribbed, or flat pan
- Coating: Kynar 500® (PVDF)
- Substrate:
 - Standard 24 gauge Galvalume

Testing Data

- For any available Test Data, Section Properties or Load Tables, please visit our download section at www.mcelroymetal.com



Residence
Meridian



Wedding Venue
Meridian

Meridian

Meridian is an economical, snap-together roofing system that is an excellent choice for commercial and residential applications. Panels are simply installed by placing pancake head fasteners in the panel's slotted flange. Meridian is installed over solid deck.

Panel Options

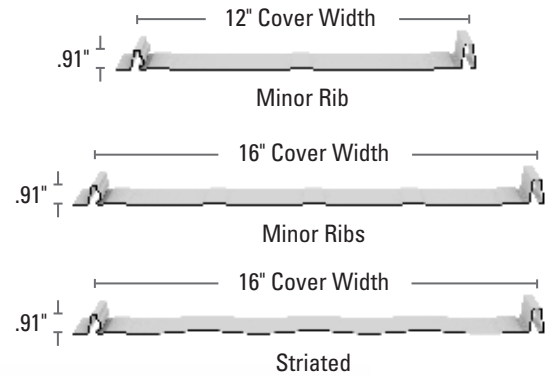

Meridian manufactured in Sunnyvale, TX features a slightly different lap and should not be mixed with panels from other facilities.

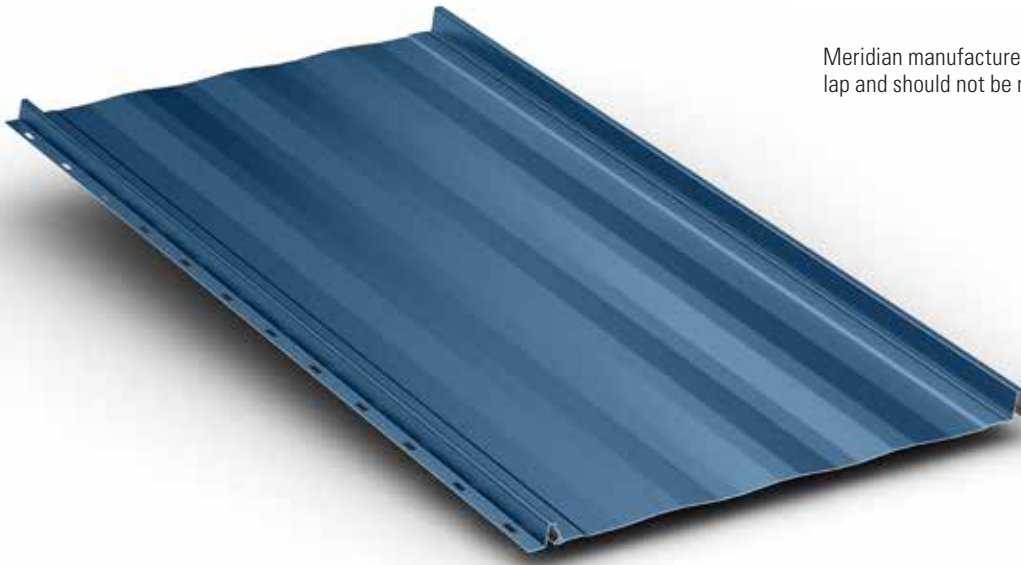

Seam Detail

Factory Eave Notch

Eave Notch
Folded In Field

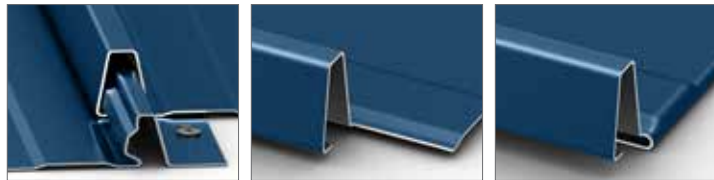

Details

- Factory formed eave notch upon request
- Minimum slope: 3:12
- Must be installed over solid deck

Panel Options

- Panel width: 12" and 16"
- Panel configurations:
 - 16" minor ribs or striated
 - 12" minor ribs or striated
- Coating: Kynar 500® (PVDF)
- Substrate:
 - Standard 26 gauge Galvalume® for 16" panels only
 - Standard 24 gauge Galvalume for 12" and 16" panels

Testing Data

- For any available Test Data, Section Properties or Load Tables, please visit our download section at www.mcelroymetal.com

Instaloc

Instaloc is a snap-together standing seam that features a 1" seam and is installed with concealed clips. Instaloc is an excellent selection for applications where greater uplift characteristics are required than achieved with Meridian.

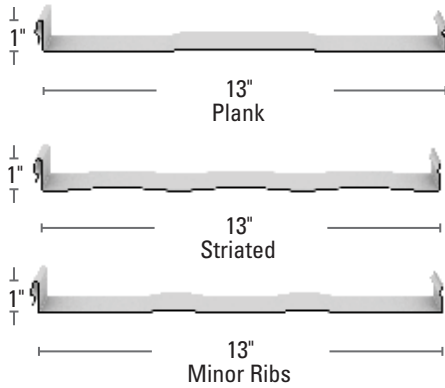

Instaloc Clip



Seam Detail



Mirage II

Mirage II is a concealed fastener roofing panel with 1 3/4" high ribs spaced 8" on center. Mirage II can be installed over solid deck or substructural members.

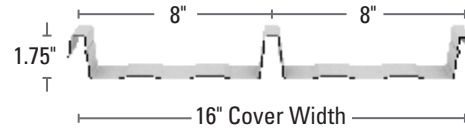

Mirage II Clip



Seam Detail



Details

- Minimum Slope: 3:12
- Must be installed over solid deck
- Factory applied sealant
- Instaloc is produced in Houston, TX

Panel Options

- Panel width: 13"
- Panel configurations: striated, plank and minor rib (striated recommended)
- Coating: Kynar 500® (PVDF)
- Substrate: Standard 24 gauge Galvalume

Testing Data

- For any available Test Data, Section Properties or Load Tables, please visit our download section at www.mcelroymetal.com

Mirage II Details

- Minimum slope: 1/4:12
- Factory applied sealant is required on slopes less than 3:12
- Can be installed over solid deck or open framing
- Mirage II is produced in Adelanto, CA

Panel Options

- Panel width: 16"
- Panel configurations: ribbed
- Coating: Kynar 500® (PVDF)
- Substrate: Standard 24 gauge Galvalume

Testing Data

- For any available Test Data, Section Properties or Load Tables, please visit our download section at www.mcelroymetal.com

MasterLok-90

MasterLok-90 is a snap-together trapezoidal standing seam system designed for projects with slopes as low as 1:12. MasterLok-90 is best suited for simple sloped roofs without dormers, hips, valleys or other special conditions. MasterLok-90 is installed over solid deck or substructural members.

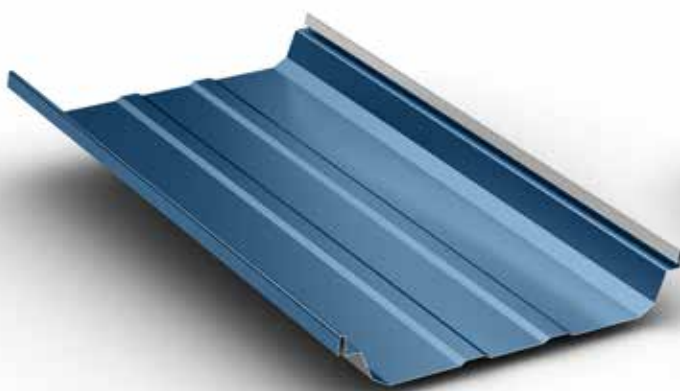

ML-90 Low Floating Clip



Seam Detail



Other utility, fixed, and floating clips available

MasterLok-90 Details

- Factory applied sealant in seam to improve weather-tightness
- Minimum slope: 1/4:12
- Can be installed over solid deck or open framing

Panel Options

- Panel width: 24"
- Coating: Kynar 500® (PVDF)
- Substrate:
 - Standard 24 gauge Galvalume®
 - Optional 22 gauge Galvalume
- Also available with Moisture-Lok

Testing Data

- For any available Test Data, Section Properties or Load Tables, please visit our download section at www.mcelroymetal.com

MasterLok-FS

MasterLok-FS is a mechanically seamed trapezoidal standing seam system designed for projects with slopes as low as 1/4:12. MasterLok-FS is best suited for simple sloped roofs without dormers, hips, valleys or other special conditions and can be installed over solid deck or substructural members.

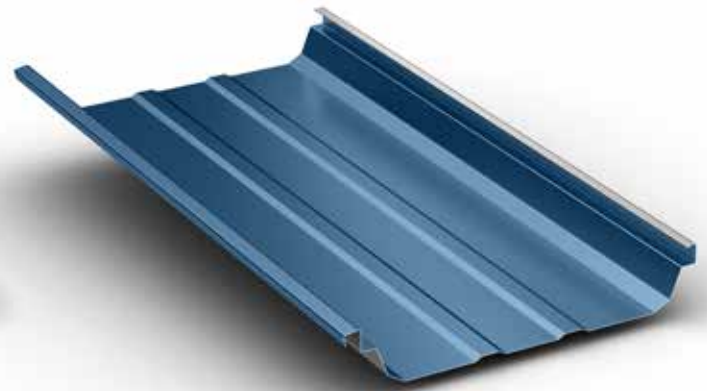

ML-FS Low Floating Clip



Before Seaming



After Seaming



Other floating clips available

MasterLok-FS Details

- Mechanically seamed profile
- Factory applied sealant in seam to improve weather-tightness
- Minimum slope: 1/4:12
- Can be installed over solid deck or open framing

Panel Options

- Panel width: 24"
- Coating: Kynar 500® (PVDF)
- Substrate:
 - Standard 24 gauge Galvalume
 - Optional 22 gauge Galvalume

Testing Data

- For any available Test Data, Section Properties or Load Tables, please visit our download section at www.mcelroymetal.com

Soffit, Fascia & Canopy Panel



Wimberley High School
FW Panel

FW Panel

McElroy Metal's FW Panel features a 1.5" deep flush metal panel designed for usage in vertical applications. Available options include deep vee grooves, reveal 1/2" up to 3" in 1/2" increments, or a traditional smooth appearance. Regardless of the pattern, the 1.5" depth and the tongue-and-groove engagement remain the same.

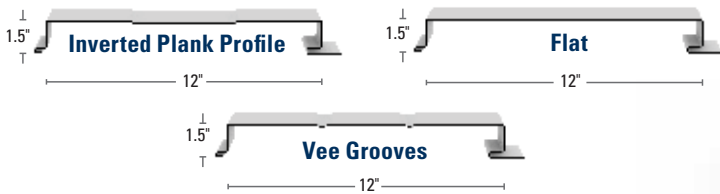

Reveal Options:



Details

- Maximum lengths:
 - 24 gauge 2' minimum and 8' maximum
 - 22 gauge 2' minimum and 15' maximum
- FW is produced in Houston, TX

Panel Options

- Panel width: 12"
- Panel configurations: inverted plank, flat, vee grooves

Reveal Options:

- Reveal Options:
 - 1" to 3" (panel remains at 12" and reveal size increases coverage)
- Coating: Kynar 500® (PVDF)
- Substrate:
 - Standard 24 gauge Galvalume®
 - Optional 22 gauge Galvalume

Testing Data

- For any available Test Data, Section Properties or Load Tables, please visit our download section at www.mcelroymetal.com

MCP

MCP (McElroy Canopy Panel) is a concealed fastener panel designed to meet the demands of canopy installations. Banks, drive-thru restaurants, convenience stores or any other building type requiring attractive and functional canopy systems are an excellent application for MCP.

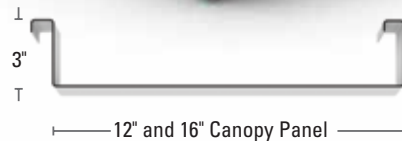

Details

- Maximum length:
 - 4' minimum and 50' maximum
- MCP is produced in Sunnyvale, TX

Panel Options

- Panel width: 12" or 16"
- Panel configurations: flat pan
- Coating: Kynar 500® (PVDF)

Substrate:

- Standard 24 gauge ASTM A792 (50 ksi steel) Galvalume AZ55-Bare
- Standard 24 gauge ASTM A792 (50 ksi steel) Galvalume AZ50-Painted

Testing Data

- For any available Test Data, Section Properties or Load Tables, please visit our download section at www.mcelroymetal.com

Matrix 12" and Matrix 16"

Matrix soffit systems will add an elegant touch to any commercial or residential project. Matrix panels are easy to install. And, to minimize on-site labor, McElroy Metal inventories 11.5" and 23.5" length panels.

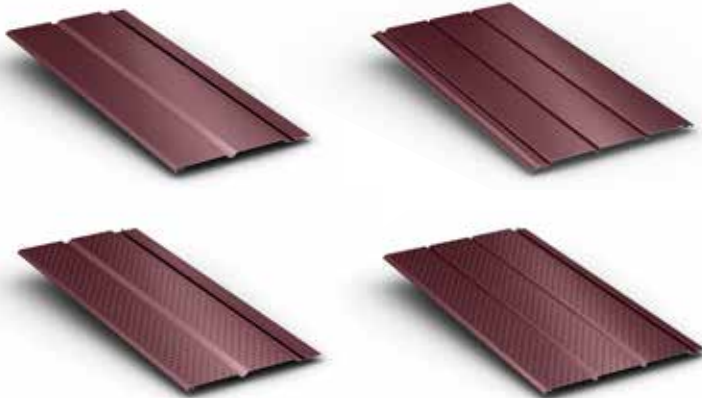
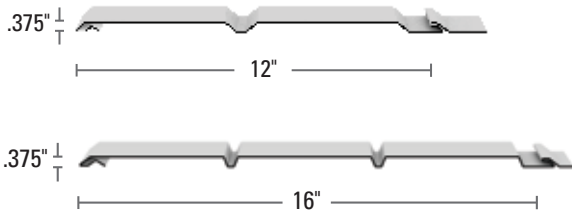

12" Panels

16" Panels

Details

- Stocked lengths: 11.5" and 23.5"
- 10% net free area with vented surface
- Matrix 12" is produced in Lewisport, KY
- Matrix 16" is produced in Marshall, MI

Panel Options

- Panel width: 12" and 16"
- Panel configurations: non-vented or vented
- Coating: Matrix 12"
 - Acrylic Coated Galvalume® 24 gauge and 29 gauge
 - Kynar 500® (PVDF) 24 gauge and 29 gauge

- Matrix 16"
 - Acrylic Coated Galvalume® 26 gauge and 29 gauge
 - Kynar 500® (PVDF) 26 gauge
 - Siliconized Polyester 29 gauge
- Substrate:
 - Standard Matrix 12" 24 gauge and 29 gauge Galvalume®
 - Standard Matrix 16" 26 gauge and 29 gauge Galvalume®

Testing Data

- For any available Test Data, Section Properties or Load Tables, please visit our download section at www.mcelroymetal.com

Marquee-Lok

Marquee-Lok is soffit and fascia panels that are coated in colors matching McElroy's standing seam systems. The end result is assurance of an exact color match between roof system, soffit, fascia and wall panels.

McElroy Metal's Marquee-Lok panel features a unique locking design that adds strength and helps to prevent the panels from unlatching due to high suction force during a wind incident. No other panel in the industry features this type of locking mechanism.

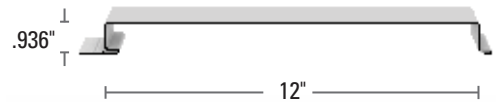

Details

- Marquee-Lok - 8% net free area with vented surface
- Maximum lengths:
 - 24 GA and .032 aluminum is 8'
 - 22 GA is 15'
- Marquee-Lok is produced in Clinton, IL, Houston, TX, Peachtree City, GA

Testing Data

- For any available Test Data, Section Properties or Load Tables, please visit our download section at www.mcelroymetal.com

Panel Options

- Panel width: 12"
- Marquee-Lok panel configurations:
 - Non-vented: flat or double pencil ribs (on-center spacing with double pencil ribs is 4")
 - Vented: flat or single pencil rib
- Coating: Kynar 500® (PVDF)
- Substrate:
 - Standard 22 gauge Galvalume
 - Optional 24 gauge Galvalume

Concealed Fastener Wall Panel



Humane Society
Wave

Wave

Available in both fixed and floating systems, McElroy Metal's Wave panels are concealed fastener wall panels that can be installed vertically or horizontally over solid substrate or subframing. Wave Fixed is installed with Wave's integral fastening flange which is roll formed into the panel during the manufacturing process and can be utilized for panel lengths of 40' or less. Wave Floating panels utilize separate clips and should be specified for panel lengths of 40' or greater.

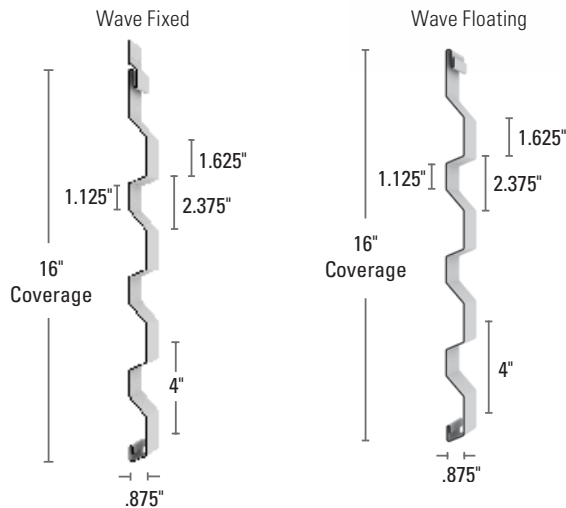
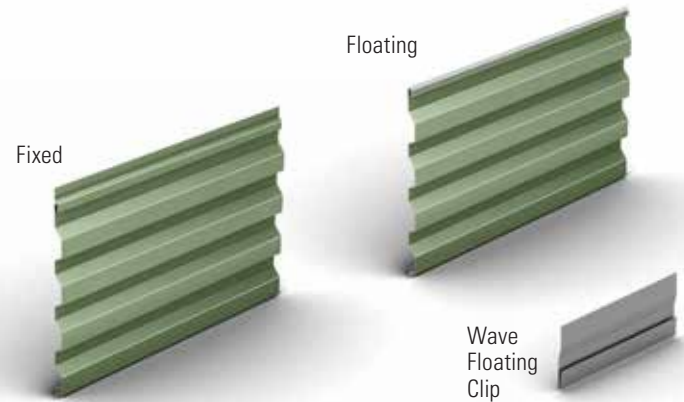

Details

- Concealed fastener wall panel
- Typically installed horizontally, but can be installed vertically
- Wave Fixed used for panel lengths 40' or less
- Wave Fixed has a concealed fastening flange
- Wave Floating used for panel lengths greater than 40'
- Wave Floating utilizes a clip
- Can be installed over solid deck or open framing
- Wave is produced in Houston, TX

Panel Options

- Panel width: 16"
- Coating: Kynar 500® (PVDF)
- Substrate: Standard 24 Gauge Galvalume®
Optional 22 gauge Galvalume

Testing Data

- For any available Test Data, Section Properties or Load Tables, please visit our download section at www.mcelroymetal.com



Pre-Notched Wave Flashing

Wave pre-notched transition flashings allow for thermal expansion and contraction while providing an attractive finishing detail. Also available, Wave's pre-notched corner flashing

Visionline F-Series Wall System

Visionline F-Series Wall system is ideal as a facade or rain screen and adds architectural styling and beauty to any project at a price point much lower than ACM systems. F-Series is a solid metal, flat plate wall panel system that does not require field-applied sealants, extrusions, gaskets, or exposed fasteners, which reduces onsite labor expense. Common applications include walls, facades, and rain screen, in both large sections and for architectural accents.

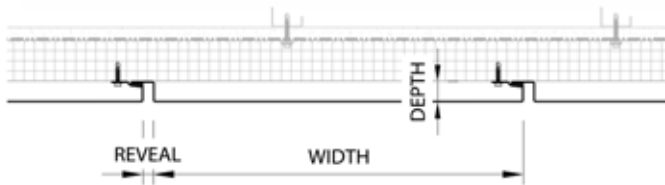

Details

- 22 Gauge Galvalume Substrate
- Kynar 500® (PVDF) coatings
- Field applied sealants, exposed fasteners, gaskets or extrusions are not required

Panel Options

- 16" x 24"
- 16" x 34"
- 16" x 54"

Testing Data

- For any available Test Data, Section Properties or Load Tables, please visit our download section at www.mcelroymetal.com

Nostalgia Board & Batten

For more details about Nostalgia Board & Batten, see page 1.

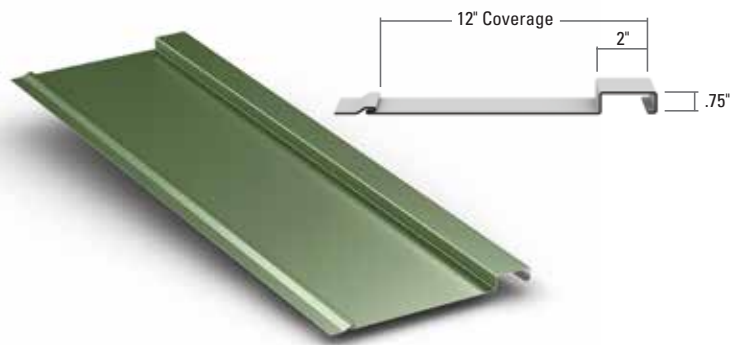

MSR

MSR is a concealed fastener wall panel by McElroy Metal that combines aesthetics and strength in one panel. MSR's bold profile will add curb appeal to most any project while providing the engineering and weather tightness characteristics demanded by architects and owners.

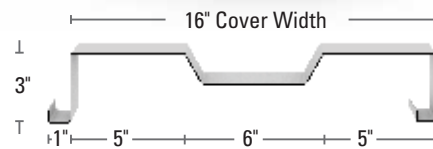

MSR with Clip



MSR with Fablok Fastener



Details

- Concealed fastener wall panel for use with Fablok fasteners or angle clips
- Also called "Shadow Rib" panel
- MSR is produced in Sunnyvale, TX

Panel Options

- Panel width: 16"
- Panel height: 3"

- Maximum panel length: 50'
- Coating: Kynar 500® (PVDF)
- Substrate:
 - Standard 24 gauge Galvalume
 - Optional 22 gauge Galvalume

Testing Data

- For any available Test Data, Section Properties or Load Tables, please visit our download section at www.mcelroymetal.com

Exposed Fastener Panels



Urgent Care
Mega Rib & Multi-Cor



Residence
Multi-Cor

Mega-Rib

Mega-Rib is a 7.2 panel that provides optimum strength and spanning capabilities. Mega-Rib is equally well suited for industrial and commercial applications.

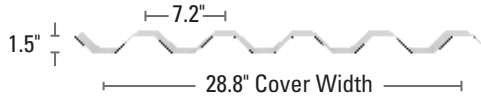

Note: Mega-Rib is also available with a 28.8" coverage, which is standard for 26 gauge panels. Please specify if 36" coverage is required.

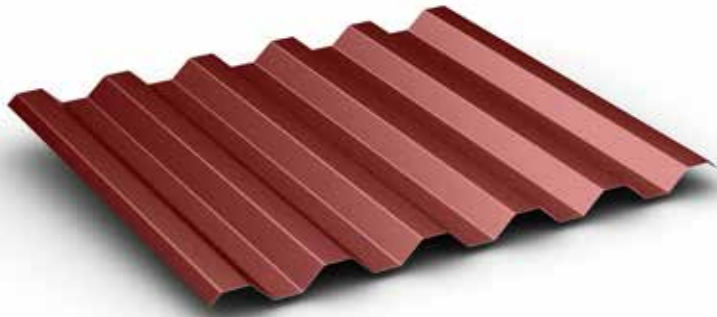

Multi-Cor & M-Cor

McElroy's corrugated panels were designed and engineered with greater-than-normal spans and load-carrying characteristics in mind. And, they quickly communicate their high-strength performance capabilities. McElroy's Multi-Cor and M-Cor are similar in design, with M-Cor offering a more subtle rib height and configuration.

Note: When used as a roof panel, Multi-Cor and M-Cor panels require a double lap (over two ribs) for installation which requires a wider coil for production. For more information, please see our website at www.mcelroymetal.com.

Multi-Cor



Details

- Minimum slope: 1:12
- Tape sealant required on all slopes
- Adelanto standard coverage for 26 gauge is 36" All other locations, standard 26 gauge coverage is 28.8" specify if 36" coverage is required
- Can be installed vertically or horizontally

Panel Options

- Coating: Kynar 500® (PVDF)

Substrate:

- Standard 24 gauge Galvalume®
- Optional 22 gauge Galvalume
- Optional 26 gauge Galvalume (narrow coverage)
- Optional 26 gauge Galvalume (full coverage Adelanto only)
- Optional 18 and 20 gauge (painted Galvalume) (limited availability)

Testing Data

- For any available Test Data, Section Properties or Load Tables, please visit our download section at www.mcelroymetal.com

Details

- Multi-Cor minimum slope: 1:12
- M-Cor minimum slope: 1:12
- Tape Sealant required on all slopes
- Multi-Cor and M-Cor can be installed over solid deck or open framing
- Multi-Cor and M-Cor are produced in Bossier City, LA

Panel Options

- Coating:
 - Kynar 500® (PVDF)
 - Silicone Modified Polyester (SMP)

Substrate:

- Standard 26 gauge Galvalume
- Multi-Cor is also available in 24 and 22 gauge Galvalume
- M-Cor is also available in 29 and 24 gauge Galvalume

Testing Data

- For any available Test Data, Section Properties or Load Tables, please visit our download section at www.mcelroymetal.com



Hobby Shop
Max-Rib

Max-Rib

Max-Rib is a low profile 3/4" panel that is well suited for post frame, commercial, and residential applications.

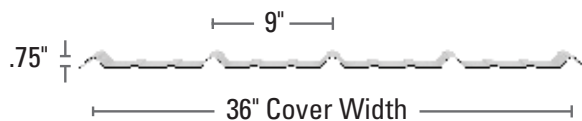

Details

- Minimum slope: 1:12 (with sealant)
- Minimum slope: 3:12 (without sealant)
- Also available with Moisture-Lok

Testing Data

- For any available Test Data, Section Properties or Load Tables, please visit our download section at www.mcelroymetal.com

Modern-Rib

Modern-Rib is an exposed fastener wall/roof panel used on slopes down to 1:12. Combining the economics of an exposed fastener panel along with major ribs that simulate standing seam panels, Modern-Rib adds beauty and sophisticated styling to residential roofs and post frame structures.



Details

- Minimum slope: 1:12 (with sealant)
- Minimum slope: 3:12 (without sealant)
- Tape sealant is required in seams (side laps) on slopes 3:12 to 1:12
- Must be installed over solid decking for roofing applications

Testing Data

- For any available Test Date, Section Properties or Load Tables, please visit our download section at www.mcelroymetal.com

Mesa

Mesa is a patent and copyright protected panel that features a nearly invisible lap. Designed for Post Frame and residential applications, Mesa will add beauty to any project.

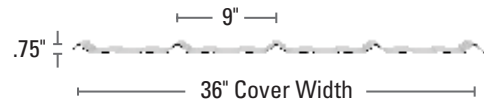

Details

- Minimum slope: 1:12 (with sealant)
- Minimum slope: 3:12 (without sealant)
- Patent and copyright protected
- Nearly invisible lap

- Ideal for post frame structures and residential roofing
- Also available with Moisture-Lok

Testing Data

- For any available Test Date, Section Properties or Load Tables, please visit our download section at www.mcelroymetal.com

5V

Homeowners across the country are discovering that metal roofing not only adds value to their home, but provides beauty as well. McElroy's 5V panel incorporates a classic design that will add beauty to any residential or commercial project.



Details

- Minimum slope: 3:12 with sealant
- 5V must be installed over solid decking
- 5V is produced in Ashburn, GA and Merkel, TX

Testing Data

- For any available Test Data, Section Properties or Load Tables, please visit our download section at www.mcelroymetal.com

U-Panel

U-Panel is an exposed fastener wall and roof panel that is also used extensively as a liner or partition panel.

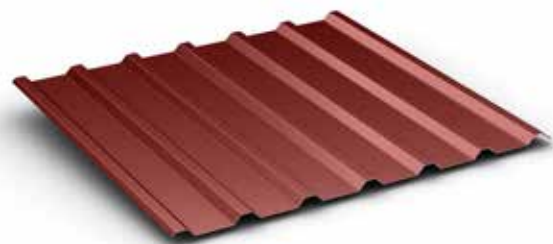
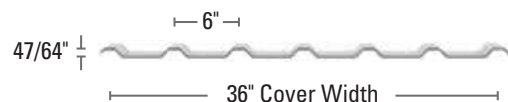

Details

- Minimum slope: 2:12 with sealant

Testing Data

- For any available Test Data, Section Properties or Load Tables, please visit our download section at www.mcelroymetal.com

Oil canning (pan wave) is a natural occurrence in metal panels and is not a cause for panel rejection.

Barndo
Multi-Rib



Town Homes
Mini-Rib



R-Panel

R-Panel is a multi-use roof and wall panel used primarily in pre-engineered metal building applications.

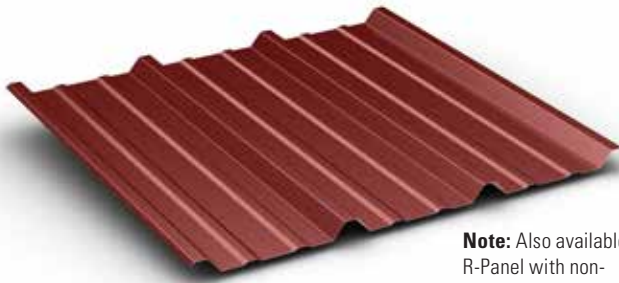
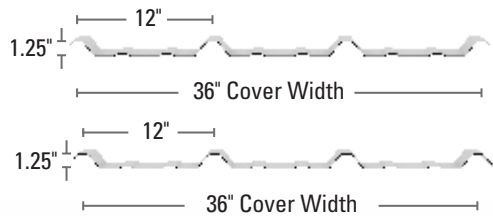

Note: Also available, R-Panel with non-purlin bearing leg

Details

- Minimum slope: 1:12 (with sealant)
- Also available with Moisture-Lok

Testing Data

- For any available Test Data, Section Properties or Load Tables, please visit our download section at www.mcelroymetal.com

Multi-Rib

Multi-Rib is a multi-use roof and wall panel used primarily in pre-engineered metal building applications.

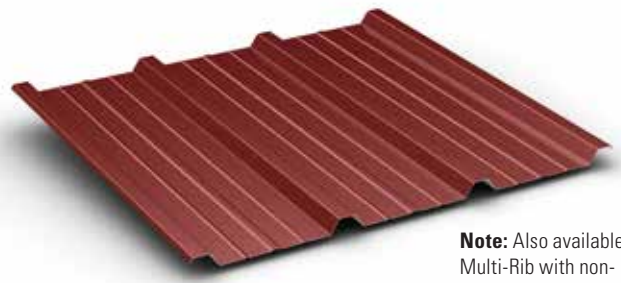
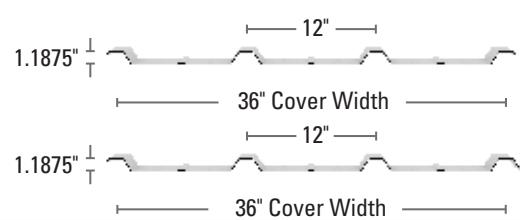

Note: Also available, Multi-Rib with non-purlin bearing leg

Details

- Minimum slope: 1:12 (with sealant)
- Also available with Moisture-Lok

Testing Data

- For any available Test Data, Section Properties or Load Tables, please visit our download section at www.mcelroymetal.com

Mini-Rib

The symmetrical design of McElroy's Mini-Rib panel makes it an appealing profile for wall, soffit, liner, and fascia applications.

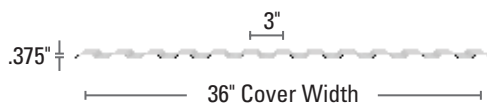

Details

- Mini-Rib is produced in Bossier City, LA

Testing Data

- For any available Test Data, Section Properties or Load Tables, please visit our download section at www.mcelroymetal.com

Multi-V

Multi-V is an exposed fastener wall panel that is designed so that fasteners are placed in the valleys, making them visually less apparent.

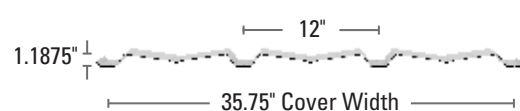

Testing Data

- For any available Test Data, Section Properties or Load Tables, please visit our download section at www.mcelroymetal.com

Metal Shingles & Tile



Residence
Tilcor

Tilcor Stone Coated Roofing

Tilcor CF Shingle is the ideal solution for home and business owners that like the appearance of traditional asphalt shingles but want to take advantage of the many benefits that metal roofing provides. Unlike other stone coated systems, which leave gaps and screws exposed to the elements, CF Shingle protects all fastening elements making roofs more reliable, watertight and durable than ever before.

Tilcor Colors



Charcoal Blend



Barkwood



Oakwood



Estate Grey



Arctic Grey



Details

- Minimum slope: 3:12
- Can be installed over most existing asphalt shingles

- Weight per tile: 7.05 lbs
- Weight per square: 141 lbs./sq.
- Substrate:
- -26 Ga Zincolume

Panel Options

- Overall panel dimensions 52 5/8" x 14 9/16"
- Panel coverage 49 5/8"
- Coating: Natural stone granules in an acrylic base-coat

Testing Data

- For any available Test Data, Section Properties or Load Tables, please visit our download section at www.mcelroymetal.com

Met-Tile

Met-Tile roofing panels provide the appearance of ceramic tile roofing with all the advantages and performance of metal. Met-Tile is lightweight, energy efficient and aesthetically attractive. Since Met-Tile is a panelized roofing system, installation takes a fraction of the time required for ceramic tiles. Panels are installed vertically from eave to ridge and are secured to the deck with fasteners.

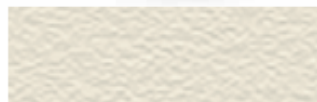

COTILLION WHITE



GALLERY BLUE



CORAL BLUE



BRAVO RED



MOROCCO RED



MEADOW GREEN



MISSION CLAY



SPANISH TILE RED



RANCHWOOD BROWN



SLATE GRAY

Details

- Minimum slope: 1 1/2:12 required with sealant
- Minimum slope: 3:12 required without sealant
- Must be installed over solid deck
- Met-Tile is produced in Sunnyvale, TX

Panel Options

- Panel lengths: 2' - 20' (in 1" increments)
- Panel width: 38 5/16"

- Panel coverage: 36 3/16"
- Steps are 1' OC
- Coating: low gloss, Kynar 500® (PVDF)
- Substrate: - 26 gauge Galvalume® stucco embossed only

Testing Data

- For any available Test Data, Section Properties or Load Tables, please visit our download section at www.mcelroymetal.com

Milan

Milan shingles add beauty and curb appeal to any home or business. Offering eight attractive Kynar 500® colors as well as Slate and Shake Kynar 500 Prints, McElroy Metal's Milan will compliment any exterior design palette.



Kynar 500® Colors

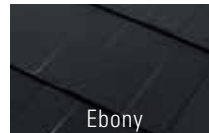

Ebony



Manor Gray

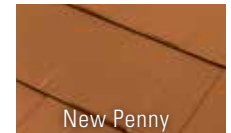

New Penny

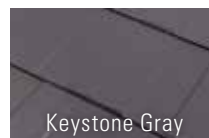

Keystone Gray

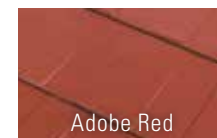

Adobe Red



Linen



Heritage Green

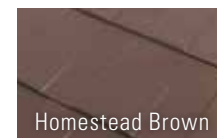

Homestead Brown

Kynar 500® Designer Prints



Blue Slate



Gray Slate



Green Slate

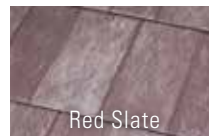

Red Slate



Classic Cedar Shake

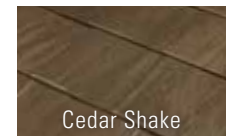

Cedar Shake



Seasoned Cedar Shake

Note: Colors are representative of colors offered and are not intended for matching purposes.

Details

- Minimum Slope 3:12
- Panel exposure: 39" x 12"
- Panels per square: 30.77
- Continuous integrated nailing flange
- Four-way interlock system secured to the roof using aluminum fastening clips
- Can be installed over most existing asphalt shingles or solid deck

Panel Options

- Weight per square: 76 lbs
- Coating: - Kynar 500® (PVDF) - Designer prints in Kynar 500® (PVDF) also available
- Substrate: - 29 gauge G90 Galvanized steel

Testing Data

- For any available Test Data, Section Properties or Load Tables, please visit our download section at www.mcelroymetal.com

Oil canning (pan wave) is a natural occurrence in metal panels and is not a cause for panel rejection.

Solar Solutions



Marshall, MI
Manufacturing Facility



Solar Solutions

McElroy Metal roofing panels are frequently the host material for crystalline solar technologies. The end-result is a functional and environmentally friendly roof system that generates renewable, clean, green energy.

Crystalline panels are the most popular photovoltaic product and offer higher efficiency and power generation. Crystalline Panels attach easily to McElroy Metal standing seam systems utilizing S-5! PV Kits, which hold the solar panels in place without penetrating the roof.



S-5! PV Kit 2.0

Crystalline Panels



Crystalline Panels



New Belgium Brewery
Medallion-Lok

Green Span Profiles



RiverTown Honda
IMP Impression



Self Storage
IMP MesaLine

Green Span Profiles

Green Span Profiles (GSP) is a McElroy Metal joint venture company that manufactures Insulated Metal Panels (IMP's) in a state-of-the-art manufacturing facility in Waller, TX.

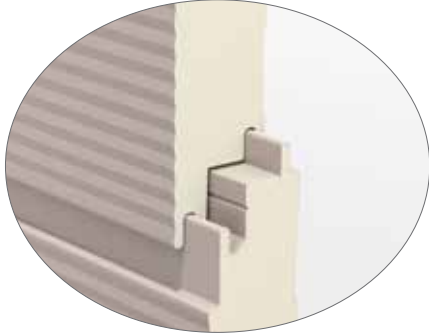

Wall Panel Seam



CleanLine
(Wall Panel)



MaxLine
(Wall Panel)



ShadowLine
(Wall Panel)



RidgeLine
(Roof Panel)



WaveLine
(Wall Panel)



HighLine
(Exposed Fastened Roof
& Wall Panel)



MesaLine
(Wall Panel)

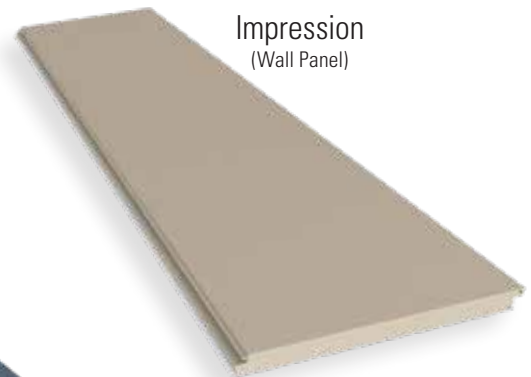

Impression
(Wall Panel)

Slit Coils, Flat Sheets, & Perforated



University of Houston
Slit Coil



Residence
Slit Coil



McElroy's slit coils and flat sheets are available in a wide variety of widths and gauges in Kynar 500® colors.



address:
1500 Hamilton RD.
Bossier City, LA 71111

email:
info@mcelroymetal.com

web:
www.mcelroymetal.com

For more information:

Light Gauge / Post Frame /
Residential Customer Service:
800-950-6534
LightGaugeCS@mcelroymetal.com

Commercial / Residential
Customer Service:
800-950-6531
CommercialCS@mcelroymetal.com

Architectural Customer Service:
800-950-6533
ArchCS@mcelroymetal.com

Western Region Customer Service -
All Products and Markets (CA, AZ, UT,
NV, WA, OR, AK, ID, MT, and WY):
800-950-6536
WesternCS@mcelroymetal.com

General Information:
318-747-8000

Marketing Department:
800-562-3576

Scan to find
McElroy Metal
locations.

