

WAVE PANEL

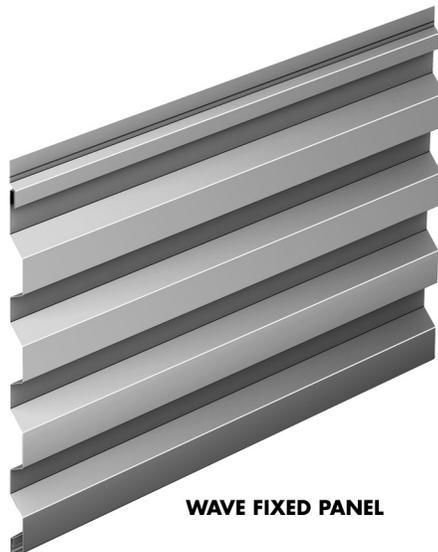

WAVE FIXED PANEL

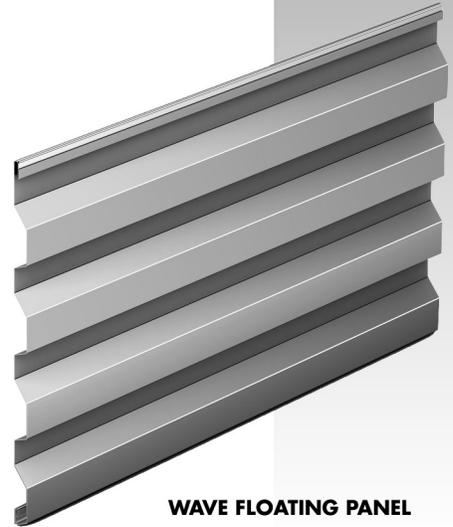

WAVE FLOATING PANEL

Panel/Trim/Accessories



WAVE

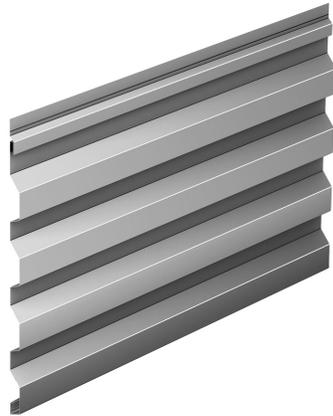

Wave Fixed

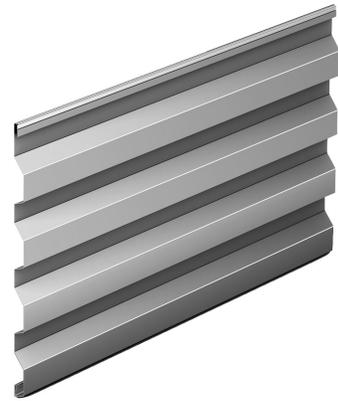

Wave Floating

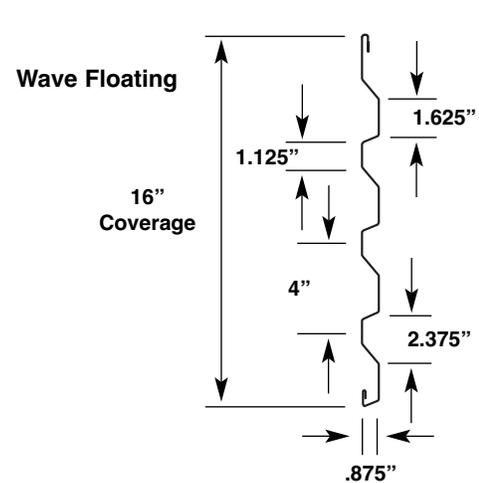
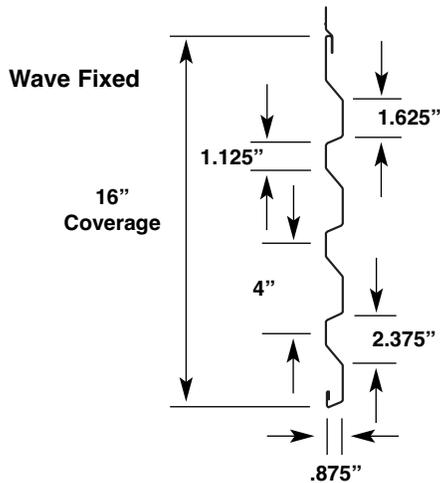

Wave Tables and Section Properties

For any available Testing Data, Section Properties, or Load Tables, please visit www.mcelroymetal.com. For additional information, please contact the **McElroy Engineering Department at 1-800-950-9082**.

Details:

- Concealed fastener wall panel
- Typically installed horizontally, but can be installed vertically
- Wave Fixed used for panel lengths 40' or less
- Wave Fixed has a concealed fastening flange
- Wave Floating is used for panels in lengths up to 50'
- Wave Floating utilizes a dip
- Wave Panel is produced in Houston, TX
- Oil canning is a natural occurrence in metal panels and is not cause for panel rejection

Panel Options:

- Panel width: 16"
- Coating:
 - Kynar 500® (PVDF)
- Substrate:
 - Standard 24 GA Galvalume®
 - Optional 22 GA Galvalume
- This panel cannot be lapped: MT171 or MT172 is required to connect panels

TRIM

24 GA.

**"1" Base Trim
MT-44**

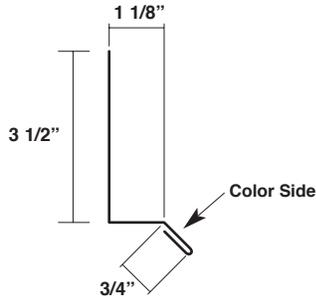

**"J" Trim
MT-49**

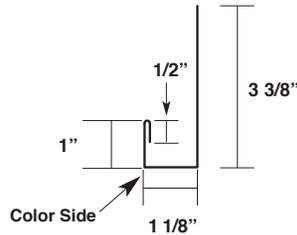

**Outside Corner Trim
MT-55**

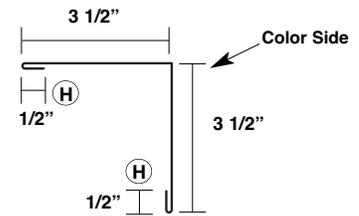

**Inside Corner Trim
MT-56**

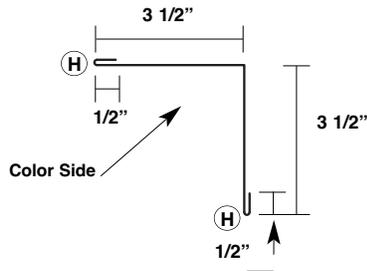

**Flat Trim Without Reveal - Notched
(Houston Plant Only)
MT-171**

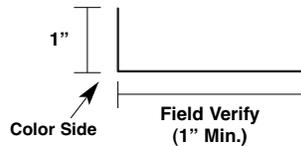

**Vertical Reveal - Notched
(Houston Plant Only)
MT-172**

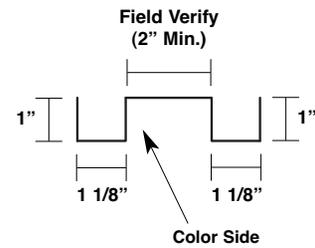

**Jamb Trim - Notched (Left)
(Houston Plant Only)
MT-173L**

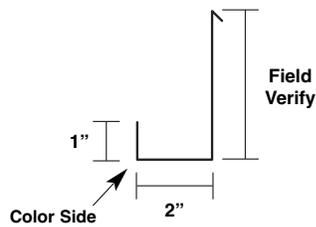

**Jamb Trim - Notched (Right)
(Houston Plant Only)
MT-173R**

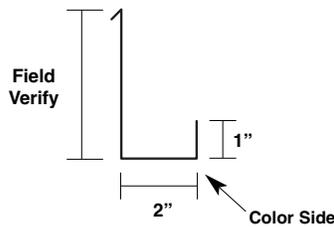

**Outside Corner Cleat - Notched (Left)
(Houston Plant Only)
MT-174**

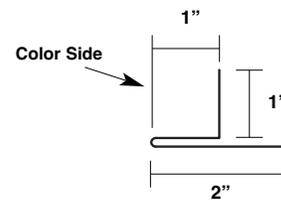

**Outside Corner Cleat - Notched (Right)
(Houston Plant Only)
MT-175**

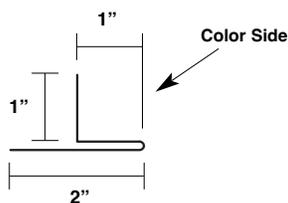

**Zee Closure
MT-184**

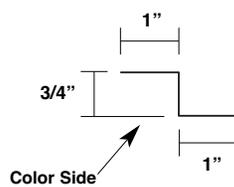

**Inside Corner Trim - Notched
MT-WAV-CRN-IS-STD**

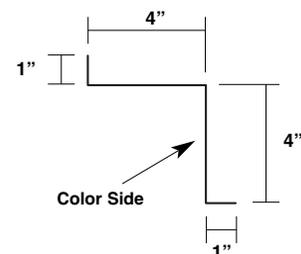

WAVE

TRIM

24 GA.

Outside Corner Trim - Notched
MT-WAV-CRN-OS-STD

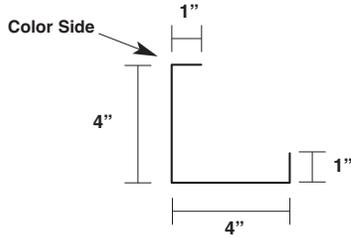

Angle Trim
MT-194

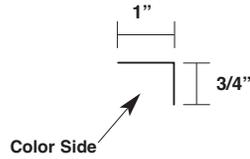

Reveal Closure
MT-195

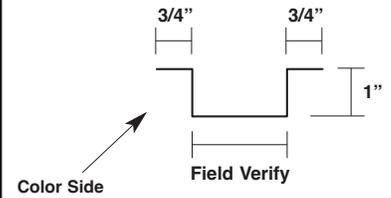

****Outside Corner Trim**
MT-197

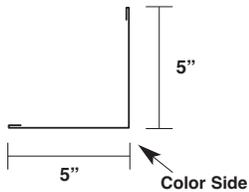

****For use in vertical installations.**

****Inside Corner Trim**
MT-198

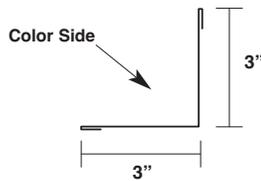

****For use in vertical installations.**

****Vertical Splice Trim**
MT-199

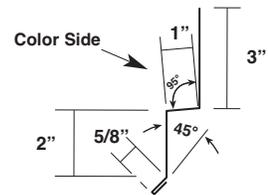

****For use in vertical installations.**

Wave Floating Clip
MT-193

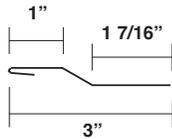

WAVE

ACCESSORIES

#10 - 12 x 1"
Type A Pancake Head
Woodgrip - Plain
Item #: 36116001

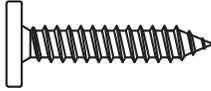

#10 - 16 x 1"
TEK2 Pancake Head
Self-Driller - Plain
Item #: 36117

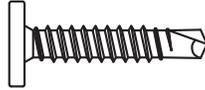

1/4 - 14 x 1 1/4"
Tek2 ZAC
(Part # varies by color.)

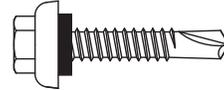

#10 - 15 x 1 1/2 HiLo ZAC
(Part # varies by color)

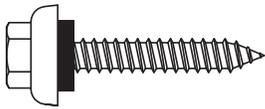

43D Pop Rivet
(Part # varies by color)

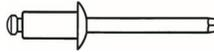

Outside Closure 32"
Item #: 96022



**Each Closure Covers 2 Panels.

Roll Tape Sealant 3/32" x 1" x 45'
Item #: 95335

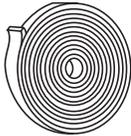

Touch-Up Paint Pen
(Part # varies by color)



Titebond Caulk Sealant
(Part # varies by color)





☆ MANUFACTURING LOCATIONS ● SERVICE CENTERS ★ MANUFACTURING AND SERVICE CENTER



CORPORATE OFFICE
 1500 HAMILTON RD.
 BOSSIER CITY, LA 71111

MANUFACTURING LOCATIONS

- | | | | | |
|--------------|--------------------|------------------|----------------|-------------|
| ADELANTO, CA | ASHBURN, GA | BOSSIER CITY, LA | CLINTON, IL | DIAMOND, MO |
| HOUSTON, TX | LEWISPORT, KY | LOCKHART, TX | MARSHALL, MI | MAUSTON, WI |
| MERKEL, TX | PEACHTREE CITY, GA | SUNNYVALE, TX | WINCHESTER, VA | |

MCELROY METAL
SERVICE
 CENTER
 EMPLOYEE OWNED

17031 Koala Road Adelanto, CA 92301	5215 Leo St. Alexandria, LA 71301	1007 Wilso Dr, Baltimore, MD 21223	1500 Hamilton Rd. Bossier City, LA 71111
3052 Yadkin Road Chesapeake, VA 23323	9476 Meadowbrook Rd. Clinton, IL 61727	3215 Highway 59 Diamond, MO 64840	390 N. Valley Dell Dr. Fenton, MO 63026
409 Lovejoy Road Ft. Walton Beach, FL 32548	3014 Lincoln Court Garland, TX 75041	1440 Aldine Bender Road Houston, TX 77032	10504 E. 59th Street Indianapolis, IN 46236
32 Industrial Circle Lancaster, PA 17601	9435 US Hwy. 60 W. Lewisport, KY 42351	2701 Cahill Street Lockhart, TX 78644	1020 Veterans Street Mauston, WI 53948
5123 Terminal Dr. McFarland, WI 53558	514 Cave Road Nashville, TN 37210	8304 Hwy. 70 E. North Little Rock, AR 72117	613 North Bierdeman Rd. Pearl, MS 39208
8511 Industrial Drive Pearland, TX 77584	2755 Hwy 60 Pendergrass, GA 30567	7450 Tower Street Richland Hills, TX 76118	8200 Berry Ave. Suite 100 Sacramento, CA 95828
1365 Dean Forest Rd. Savannah, GA 31405	7355 Oakley Industrial Blvd. Union City, GA 30291	1144 Silstar Rd. West Columbia, SC 29170	325 McGhee Rd. Winchester, VA 22603

Website: www.mcelroymetal.com • E-mail: info@mcelroymetal.com