

Medallion-Lok Panel

Product Data

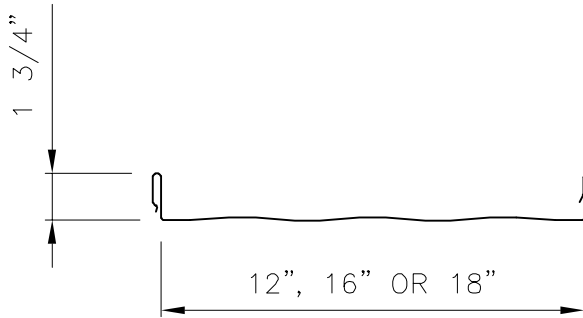

STRIATED PROFILE
(Standard)

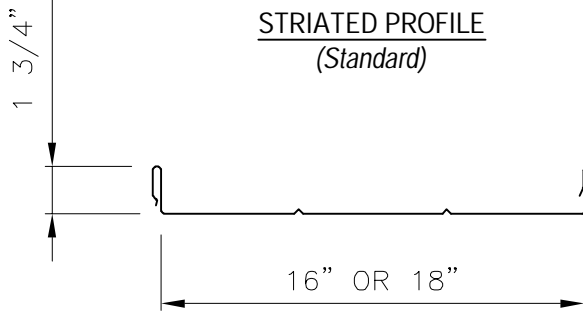

BEAD (PENCIL RIB) PROFILE
(Optional)

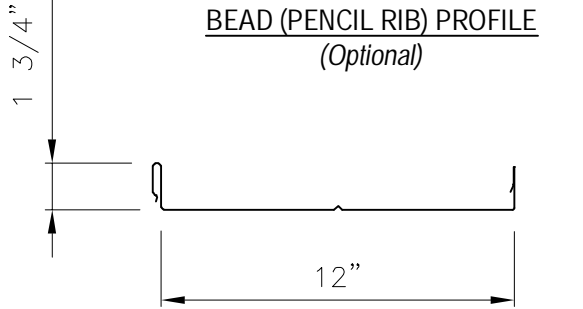

BEAD (PENCIL RIB) PROFILE
(Optional)

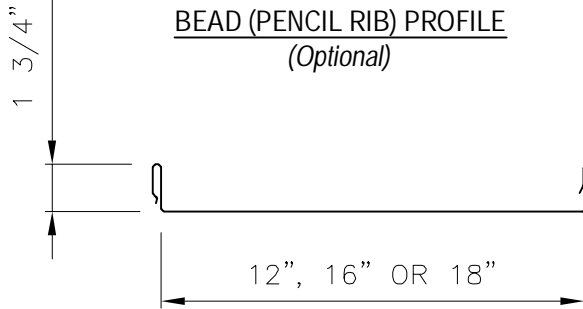

FLAT PAN PROFILE
(Optional)

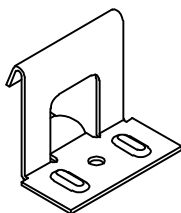

STANDARD CLIP

16 GA. Galvanized G90 - ASTM A653 (50 ksi)

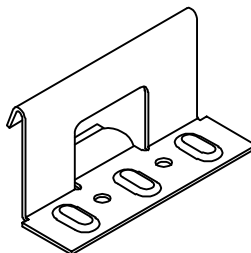

UL-90 CLIP

16 GA. Galvanized G90 - ASTM A653 (50 ksi)

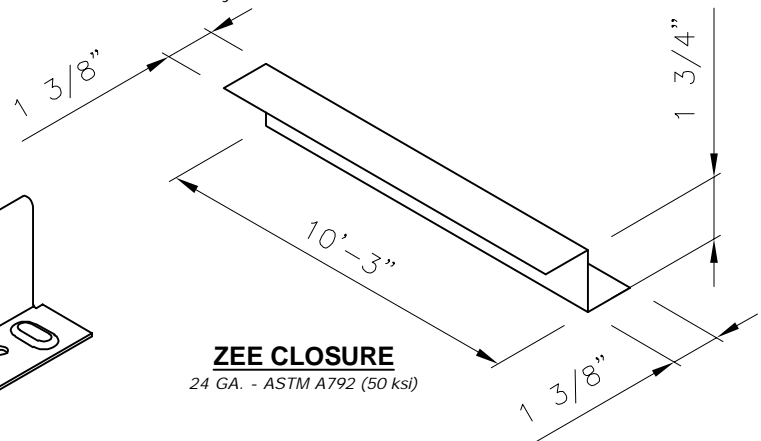

ZEE CLOSURE

24 GA. - ASTM A792 (50 ksi)

Applications

Snap Seamed roof panel used on slopes down to 3:12. Continuous length up to 75'. Please inquire for longer lengths.

Substrates

Plywood, Metal Deck, Rigid Insulation/Metal Deck or Open Framing.

Material

Standard - 24 GA. ASTM A792 (50 ksi steel) AZ55 - Bare
AZ50 - Painted
Optional - 22 GA. ASTM A792 (50 ksi steel) AZ55 - Bare
AZ50 - Painted
and .032 Aluminum (Sunnyvale Plant Only)

Manufacturing

Roll formed in factory.
Available Factory Eave Notching of 1 1/2"

Finishes

Acrylic Coated Galvalume®
Fluoropolymer (Kynar 500® PVDF resin-based)

Pan Conditions

Flat Pan, Pencil Ribbed or Striated
Oil canning is inherent in all metal panels and is not cause for panel rejection. A signed oil canning acknowledgement will be required for all orders prior to production.

Testing *

Uplift: UL 580 Class 90, ASTM E1592
Air & Water Infiltration: ASTM E1680, and ASTM E1646.
Fire Resistance: UL 263 & UL 790 Class A
Impact Testing: UL 2218 Class 4
Miami Dade Approval: NOA# 18-0327.11
Florida Product Approval: FL 1747.5 & FL 1832.7
Testing and Approvals are product specific. Please inquire for details.

NOTE:

All data represented on this sheet may not be applicable to all widths and gauges. Please contact McElroy Metal for more information.