

# WAVE PANEL INDEX

<u>DWG #:</u>	<u>DESCRIPTION:</u>	<u>IMAGE #:</u>
MT-55	Outside Corner Trim	754
MT-56	Inside Corner Trim	755
MT-171	Flat Trim w/o Revel - Notched	815
MT-172	Vertical Revel - Notched	816
MT-173-L	Jamb Trim - Notched (Left)	817
MT-173-R	Jamb Trim - Notched (Right)	818
MT-174	Outside Corner Cleat - Notched (Left)	819
MT-175	Outside Corner Cleat - Notched (Right)	820
MT-184	Wave Panel Zee Closure	831
MT-WAV-CRN-IS-STD	Inside Corner Trim - Notched	823
MT-WAV-CRN-OS-STD	Outside Corner Trim - Notched	822
MT-193	Wave Floating Clip	840
MT-194	Wave Panel Angle Trim	843
MT-195	Wave Panel Reveal Closure	844
MT-197	Outside Corner Trim	845
MT-198	Inside Corner Trim	846
MT-199	Vertical Splice Trim	847

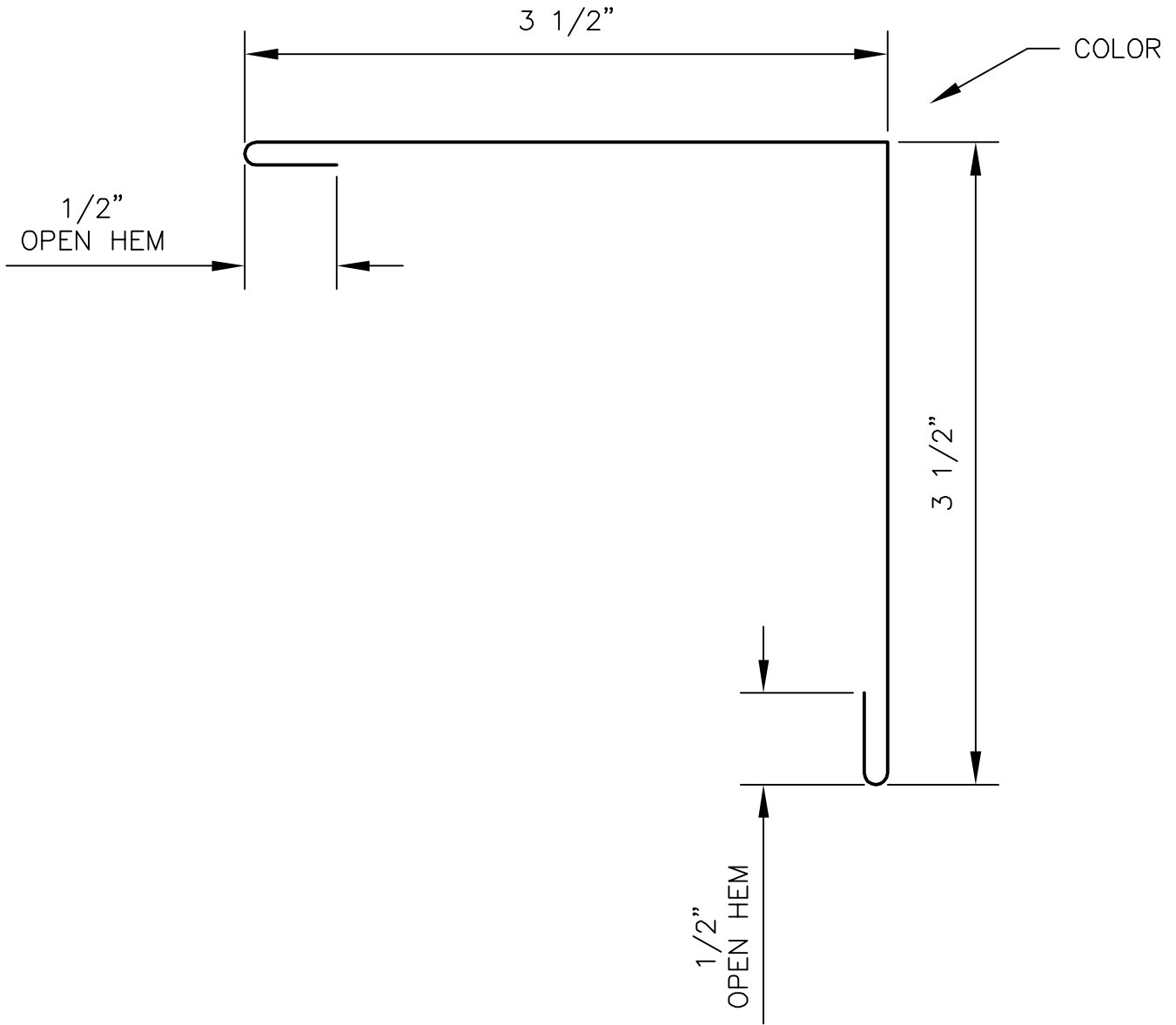

### OUTSIDE CORNER TRIM

PANEL PROFILES	GAUGE
WAVE PANEL	24
FW SERIES	24

GIRTH: 8"  
BENDS: 90° AND AS SPECIFIED

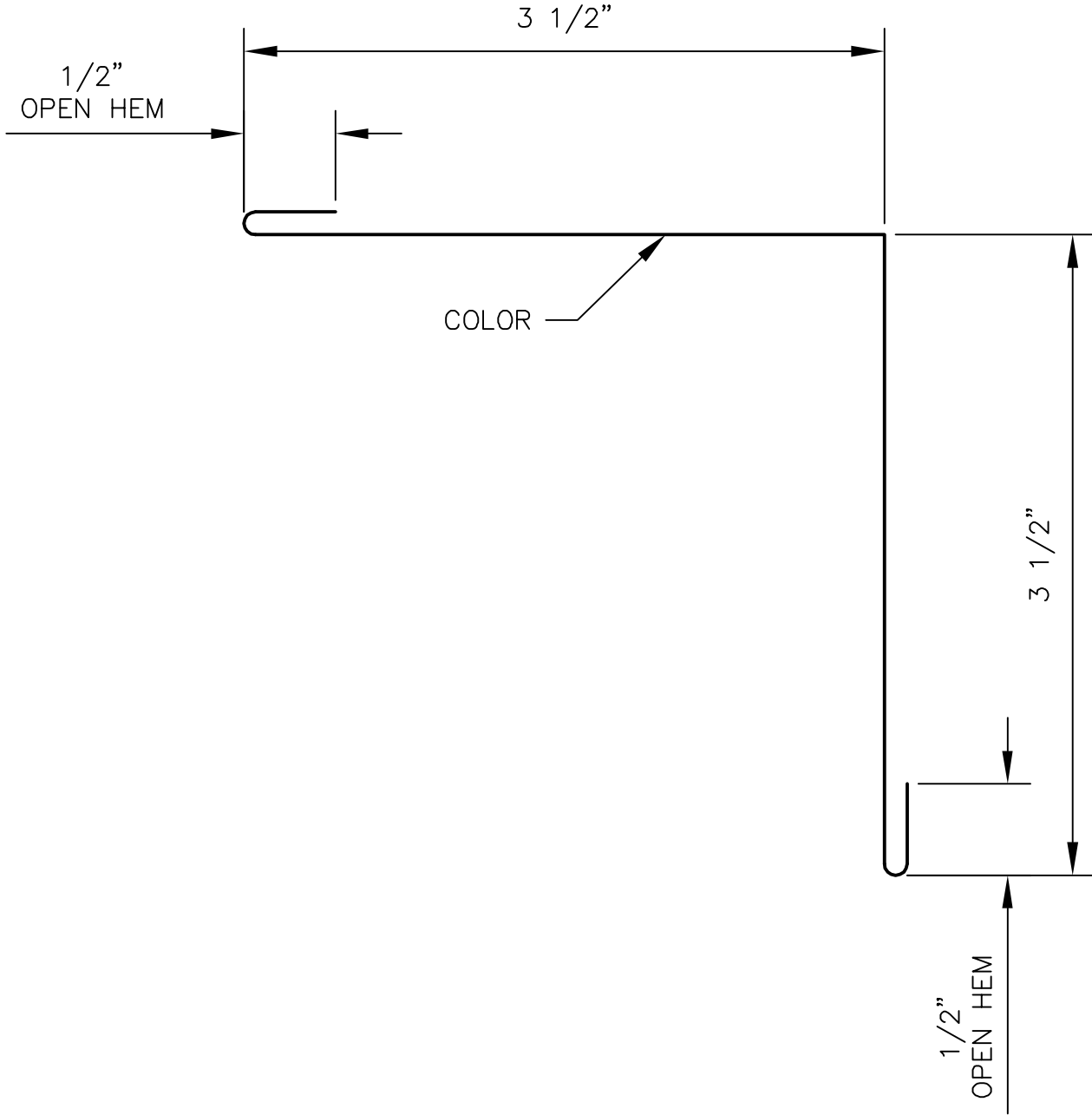

### INSIDE CORNER TRIM

PANEL PROFILES	GAUGE
WAVE PANEL	24
FW SERIES	24

GIRTH: 8"  
BENDS: 90° AND AS SPECIFIED



PAINT  
DOWN

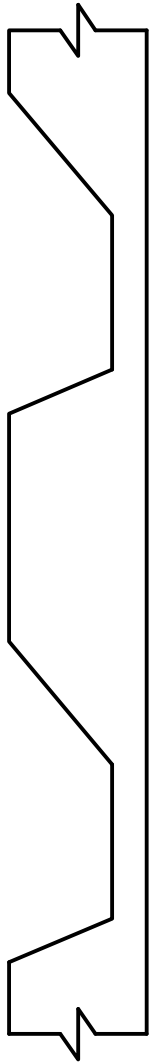

PAINT  
UP

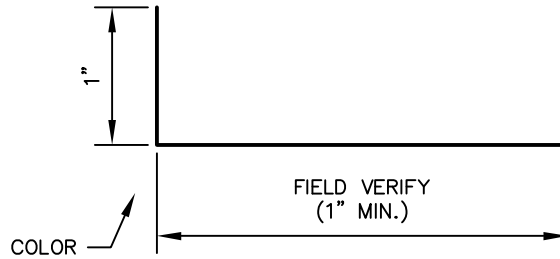

FLAT TRIM w/o REVEAL - NOTCHED

PANEL PROFILES	GAUGE
WAVE PANEL	24

GIRTH: 3" (MIN.)  
BENDS: 90°



PAINT  
DOWN

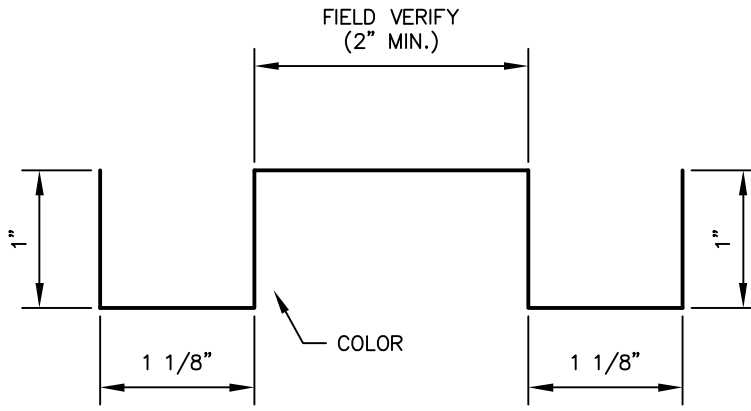
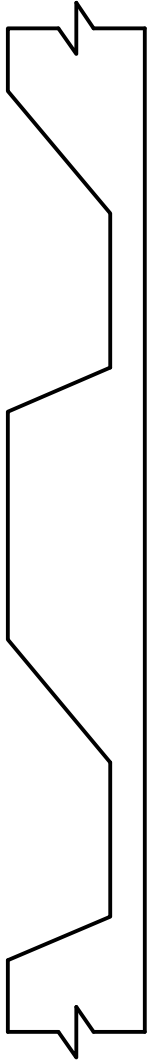

PAINT  
UP



VERTICAL REVEAL - NOTCHED

PANEL PROFILES	GAUGE
WAVE PANEL	24

GIRTH: 8 1/8" (MIN.)  
BENDS: 90°

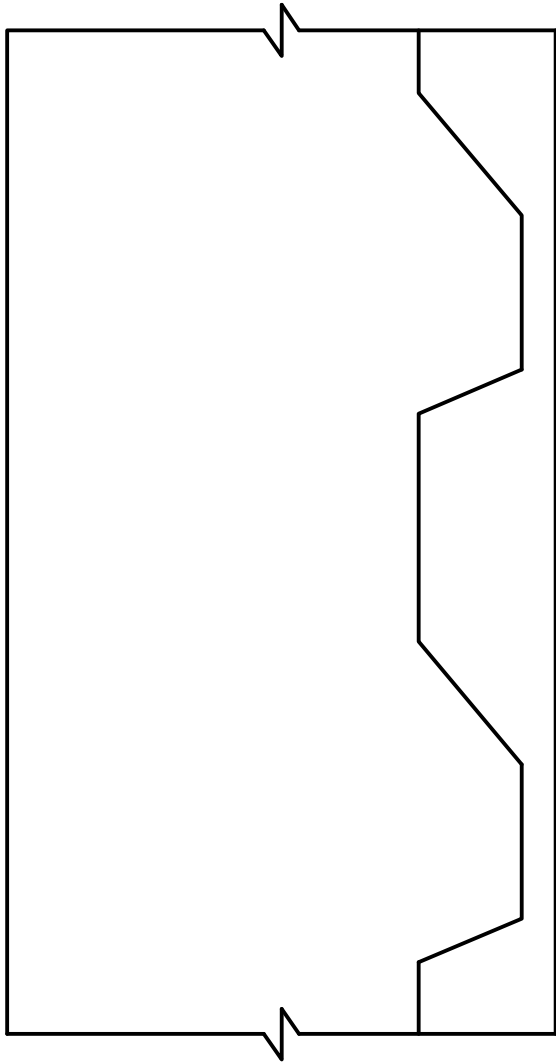

PAINT  
DOWN

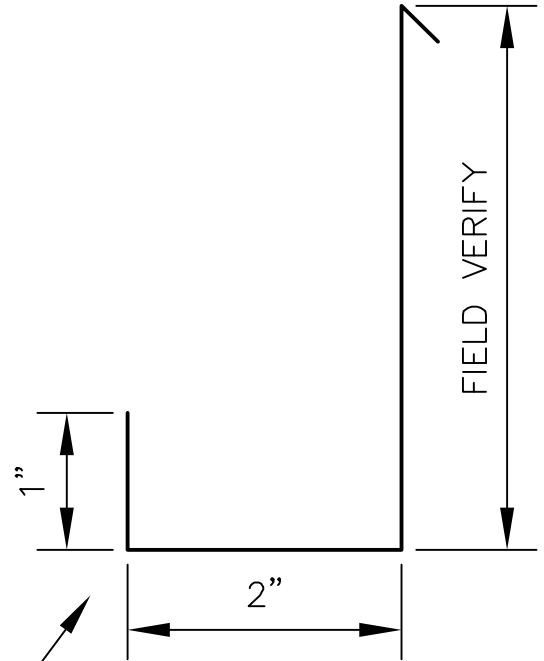

COLOR

JAMB TRIM - NOTCHED (LEFT)

PANEL PROFILES	GAUGE
WAVE PANEL	24

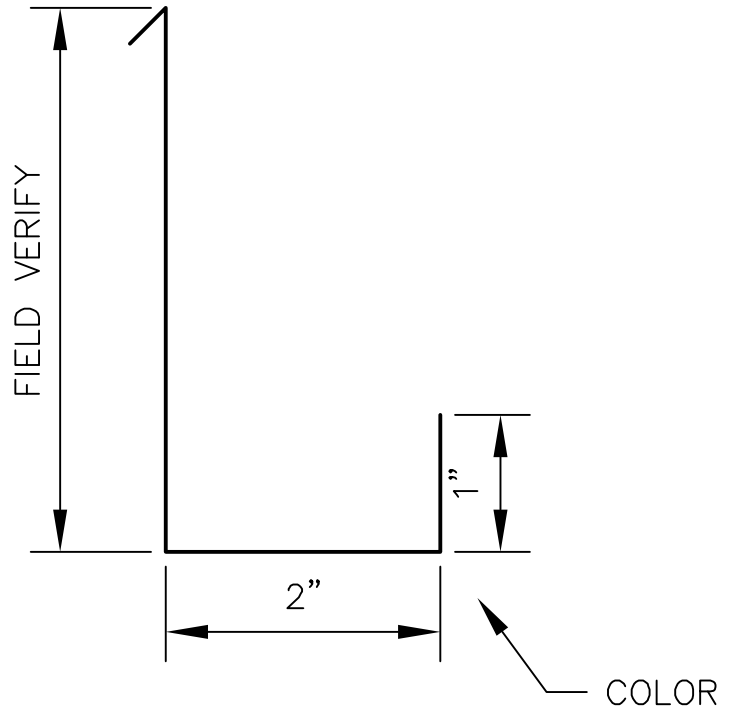
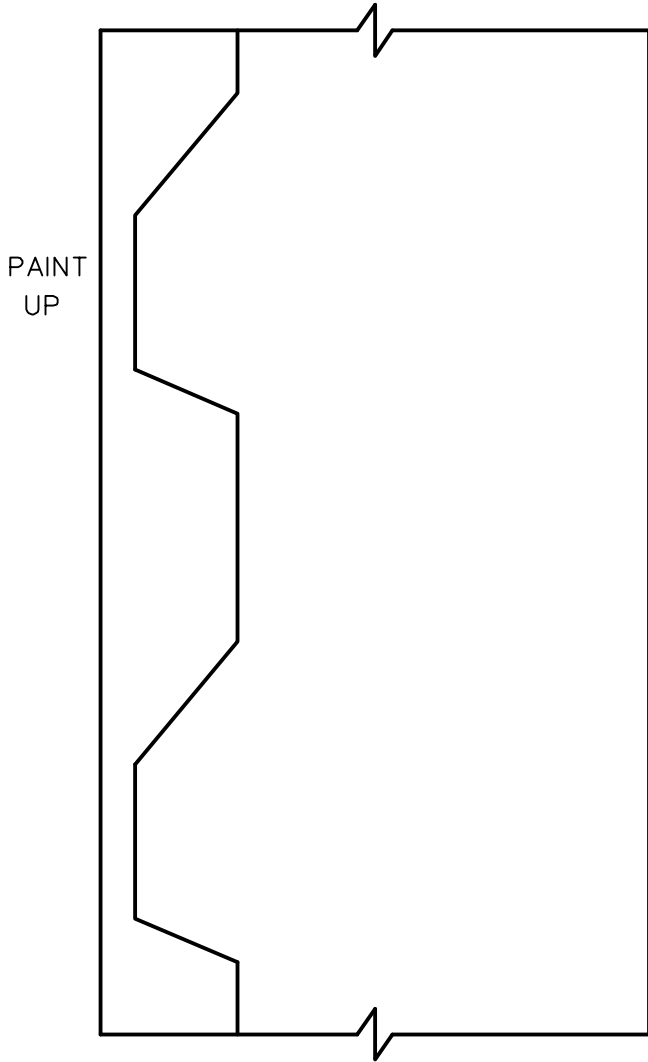

JAMB TRIM - NOTCHED (RIGHT)

PANEL PROFILES	GAUGE
WAVE PANEL	24

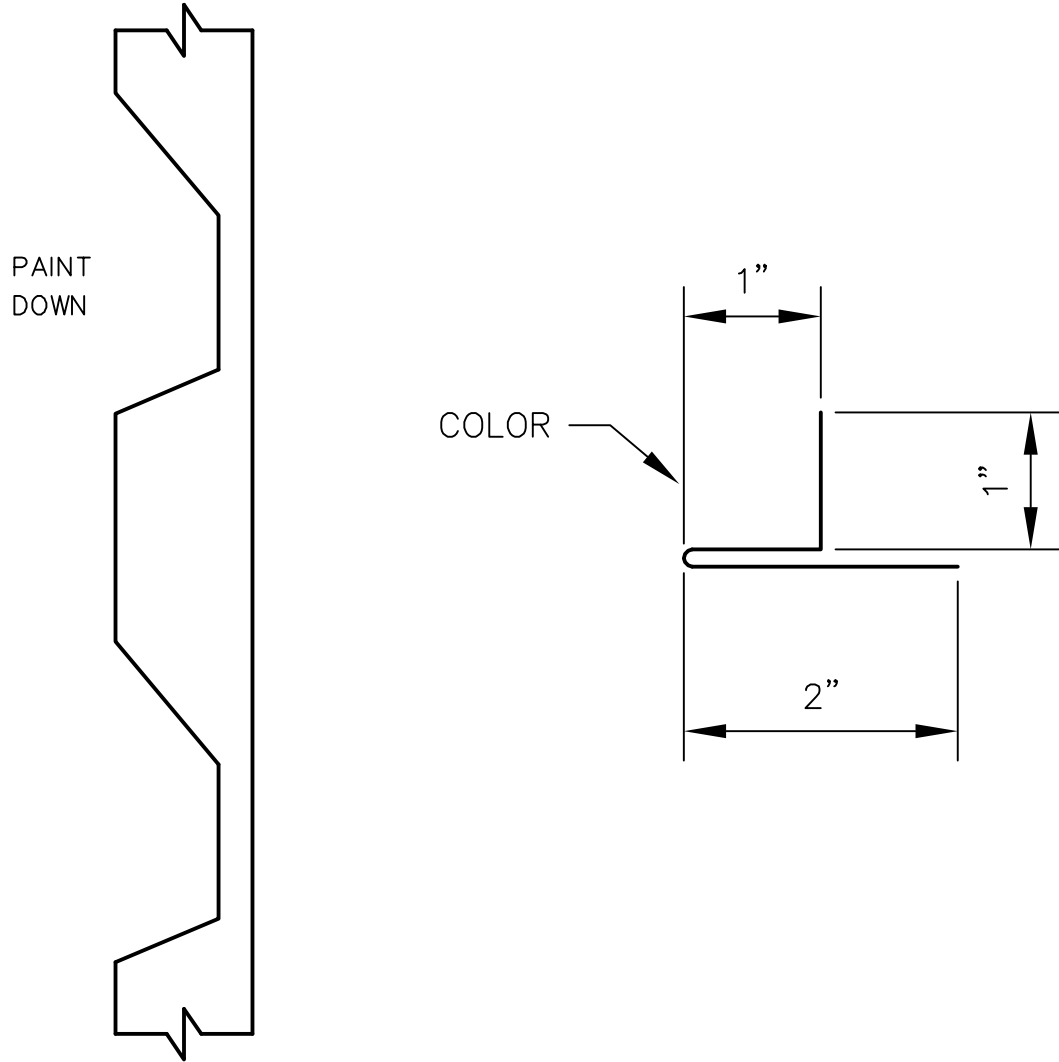

OUTSIDE CORNER CLEAT - NOTCHED (LEFT)

PANEL PROFILES	GAUGE
WAVE PANEL	24



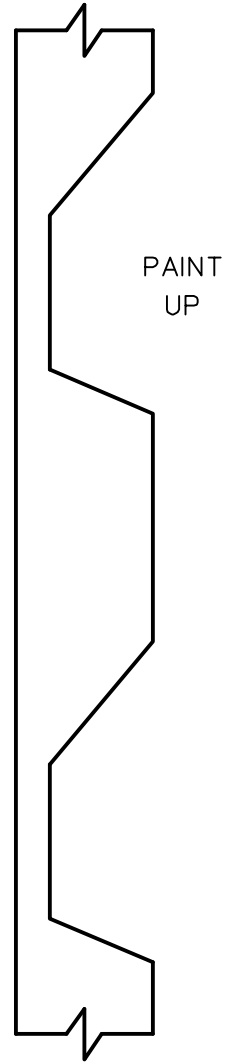
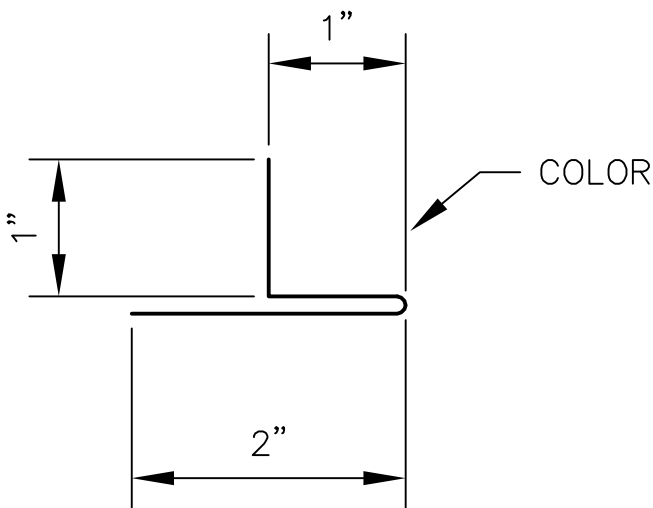

OUTSIDE CORNER CLEAT - NOTCHED (RIGHT)

PANEL PROFILES	GAUGE
WAVE PANEL	24

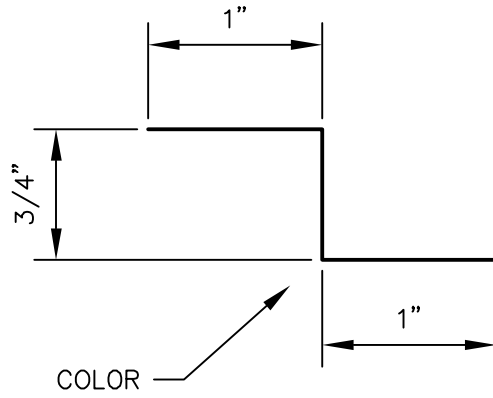

WAVE PANEL ZEE CLOSURE

PANEL PROFILES	GAUGE
WAVE PANEL	24

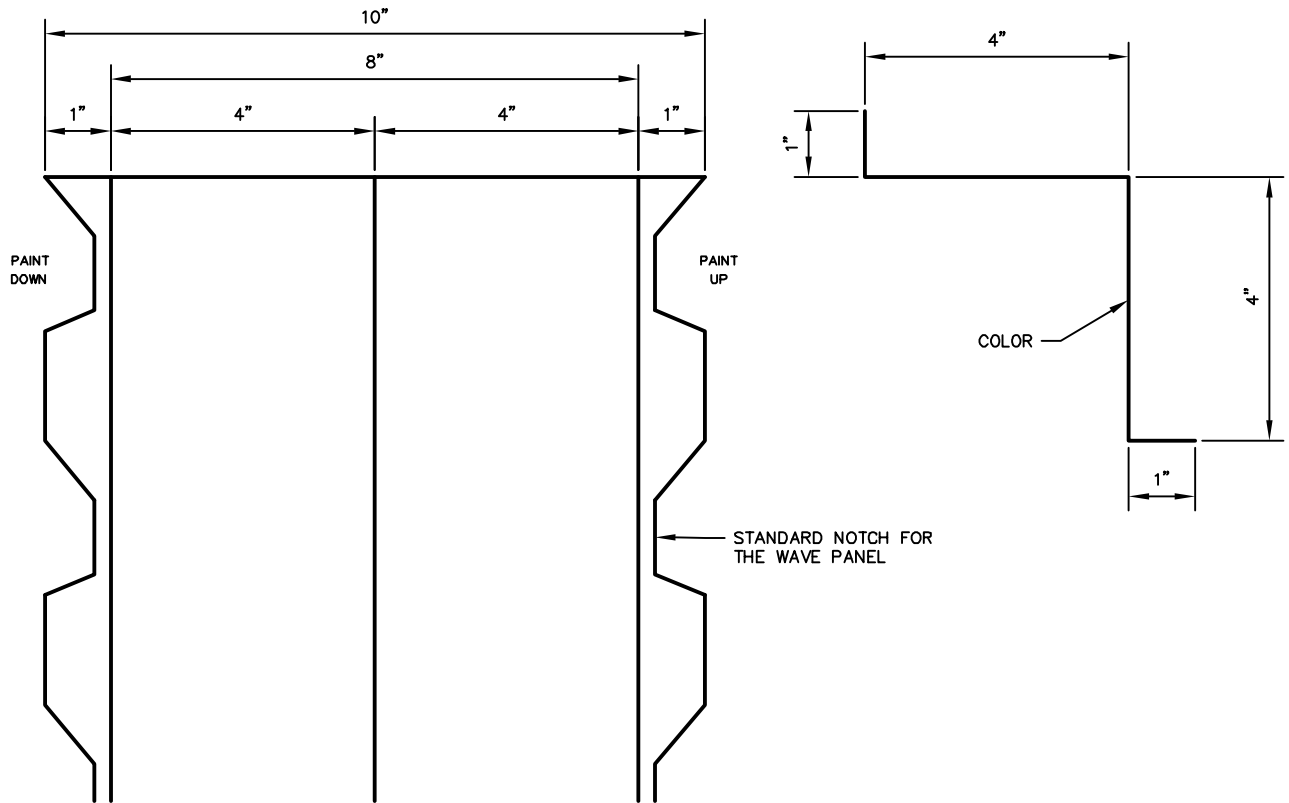

INSIDE CORNER TRIM - NOTCHED

PANEL PROFILES	GAUGE
WAVE PANEL	24

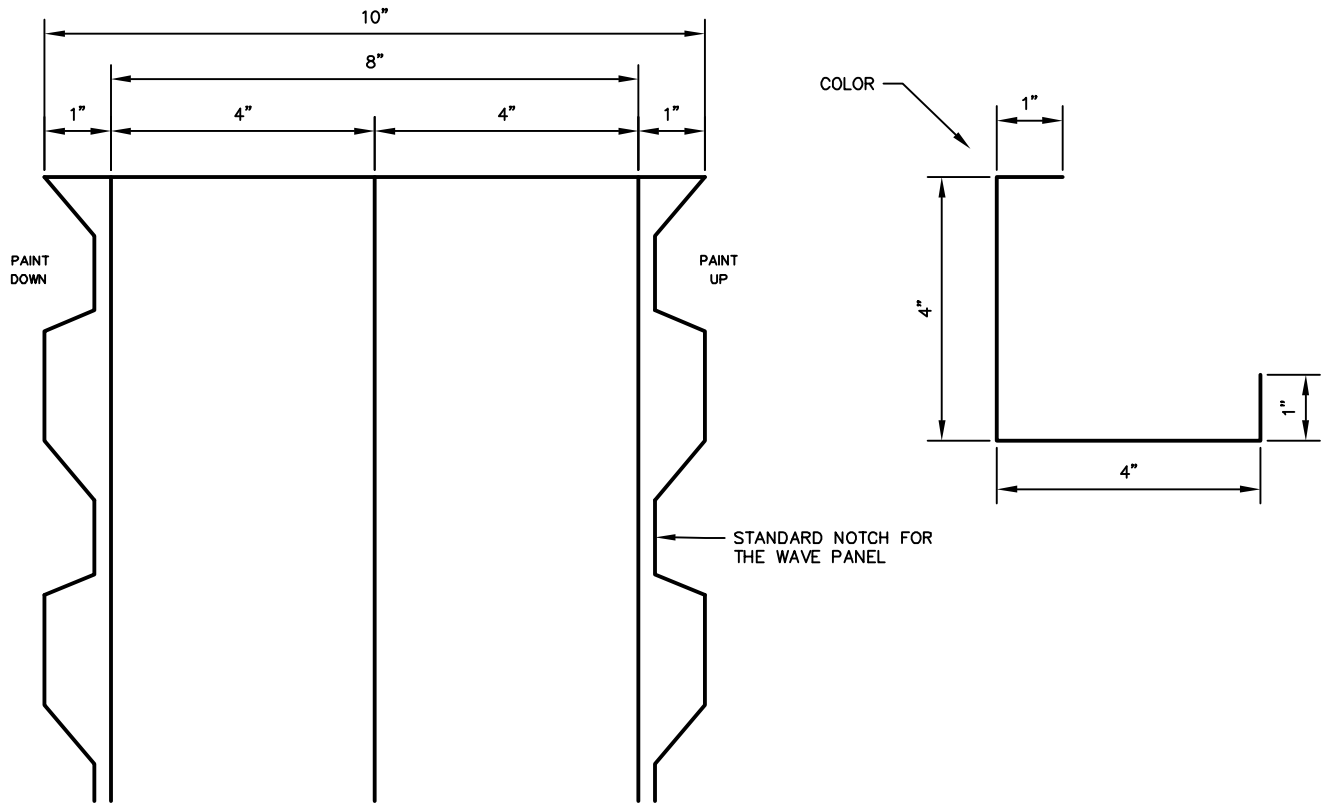

OUTSIDE CORNER TRIM - NOTCHED

PANEL PROFILES	GAUGE
WAVE PANEL	24

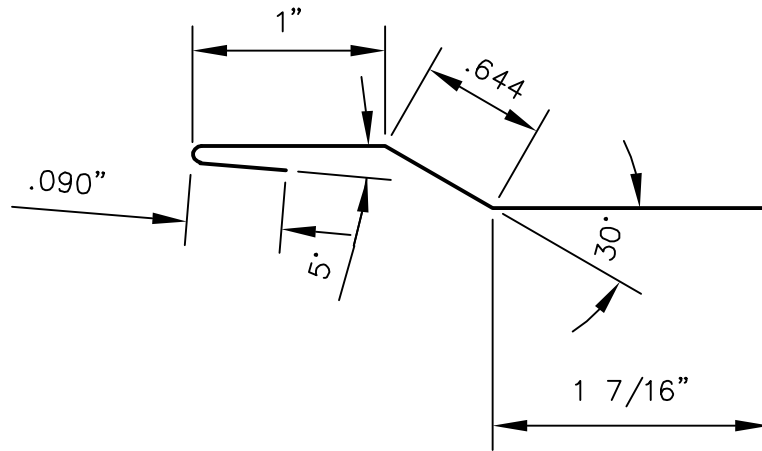

WAVE FLOATING CLIP

PANEL PROFILES	GAUGE
WAVE PANEL	24

10-23-19 rev.  
10-30-18 rev.  
9-15-16

GIRTH: 3 5/8"  
BENDS: ROLLFORMED

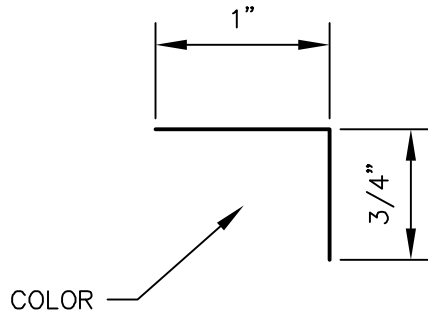

WAVE PANEL ANGLE TRIM

PANEL PROFILES	GAUGE
WAVE PANEL	24

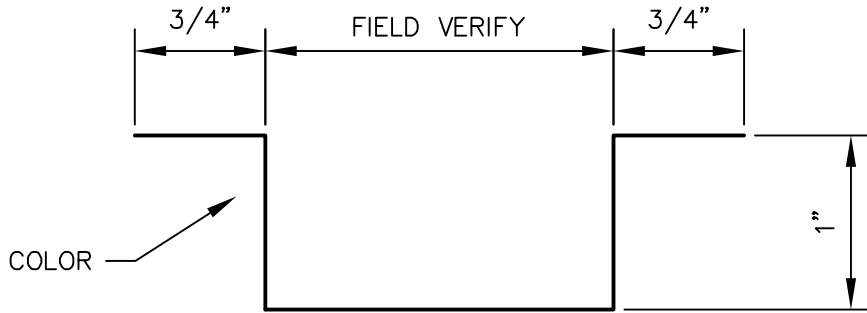

WAVE PANEL REVEAL CLOSURE

PANEL PROFILES	GAUGE
WAVE PANEL	24

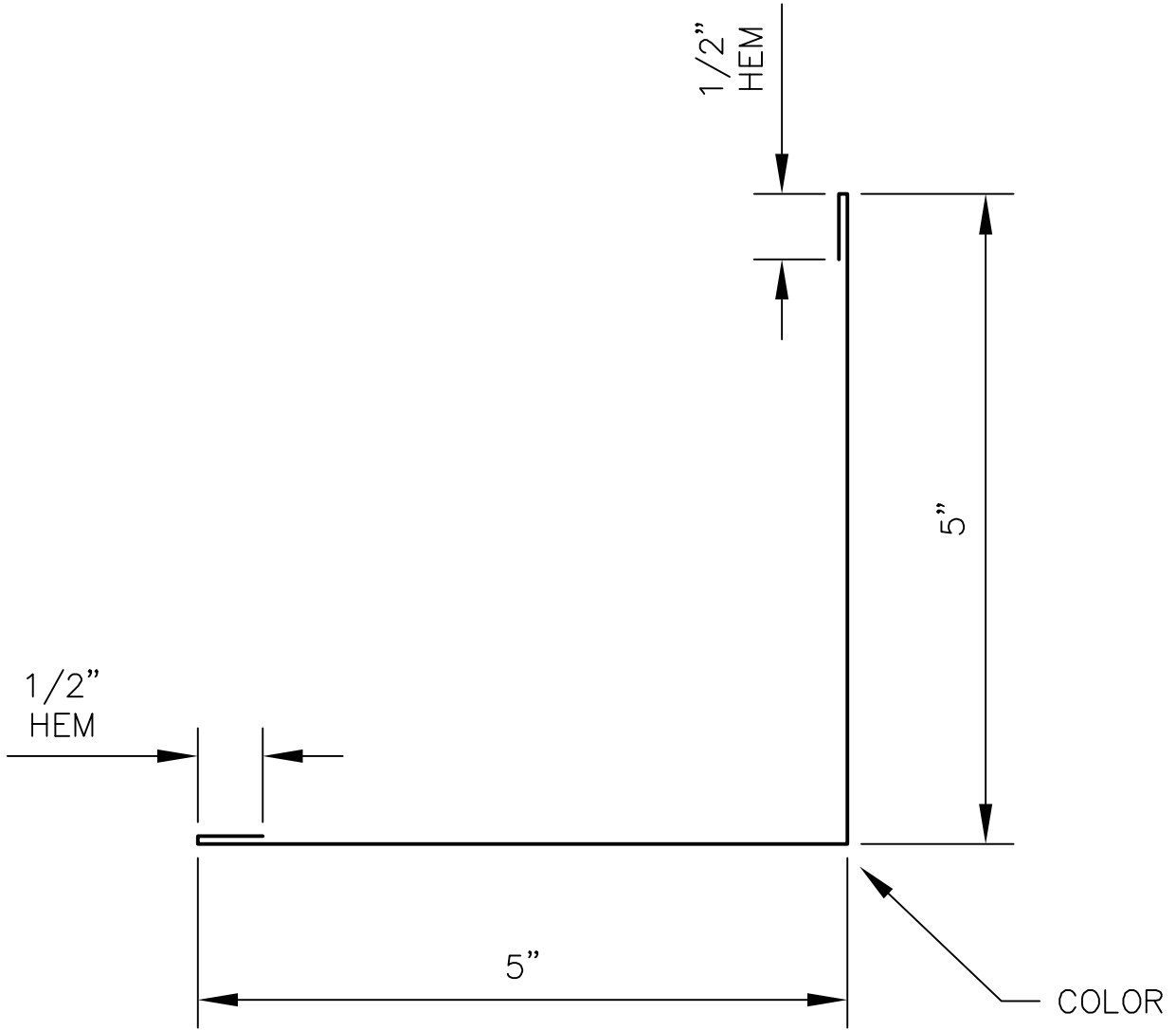

OUTSIDE CORNER TRIM

PANEL PROFILES	GAUGE
WAVE PANEL	24



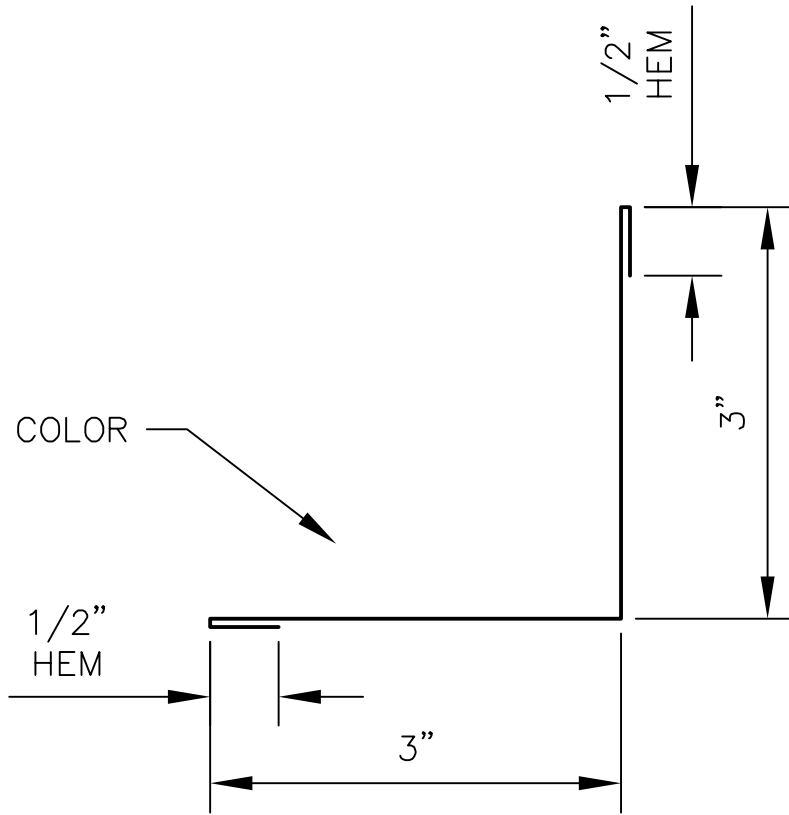

INSIDE CORNER TRIM

PANEL PROFILES	GAUGE
WAVE PANEL	24

GIRTH: 7"  
BENDS: 90° AND AS SPECIFIED

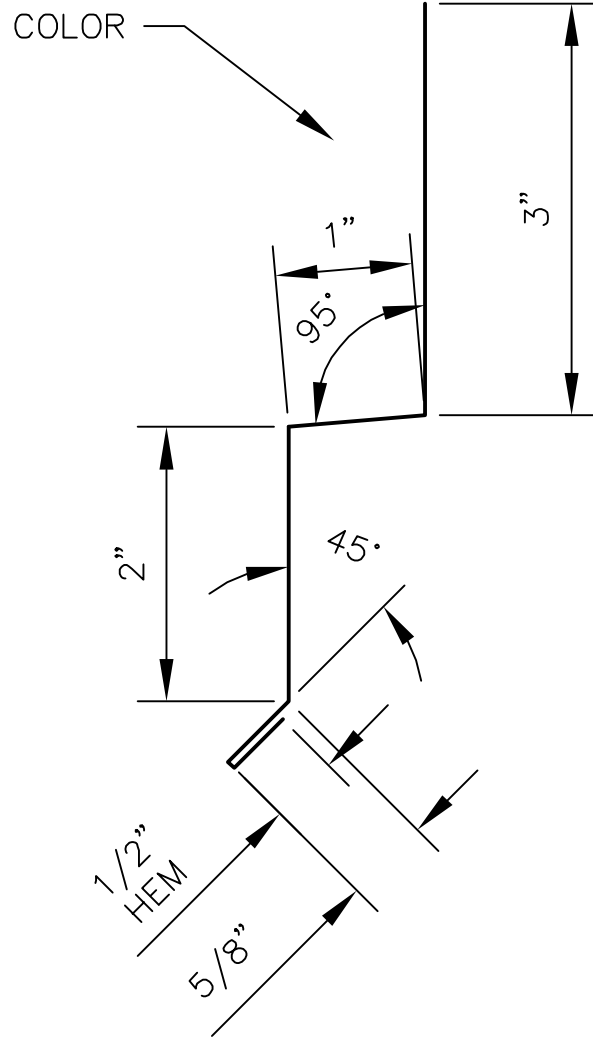

VERTICAL SPLICE TRIM

PANEL PROFILES	GAUGE
WAVE PANEL	24

GIRTH: 7 1/8"  
BENDS: 90° AND AS SPECIFIED