

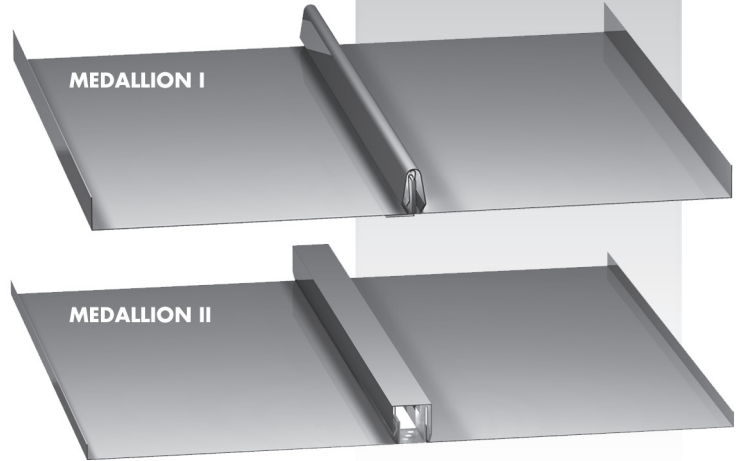

MEDALLION II  
MEDALLION I



Panel / Trim /Accessories





# MEDALLION I

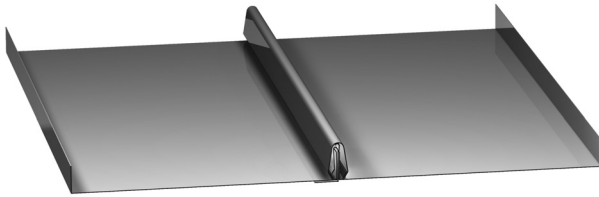



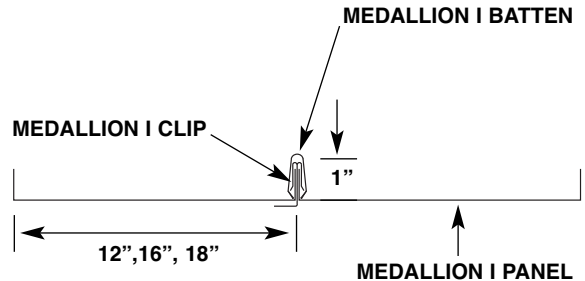

**Medallion I**

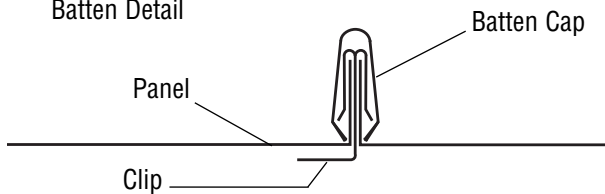

Medallion I  
Seam &  
Batten Detail



## Medallion I Pan Conditions

MEDALLION I STRIATED*	 12", 16", 18"
MEDALLION I FLAT PAN	 12", 16", 18"
MEDALLION I DOUBLE PENCIL RIBS	 16" and 18" Only
MEDALLION I SINGLE PENCIL RIB	 12" Only

\*Recommended Pan Condition

For any available Testing Data, Section Properties, or Load Tables, please visit [www.mcelroymetal.com](http://www.mcelroymetal.com). For additional information, please contact the **McElroy Engineering Department at 1-800-950-9082**.

### Details:

- Minimum slope: 3:12
- Must be installed over solid decking
- Curving: Medallion I only - minimum radius 30"
- Oil canning is a natural occurrence in metal panels and is not a cause for panel rejection

### Panel Options:

- Panel width: 12", 16", and 18"
- Panel configurations: striated, ribbed or flat pan (striated recommended)
- Coating:
  - Kynar 500® (PVDF)
- Substrate:
  - Standard 24 GA Galvalume®

### Notes:

- Please contact a McElroy representative for specific pricing, lead times, special colors or gauges that may not be on a McElroy Metal color chart.
- Contents in this manual are subject to change without notice. To confirm this book is the most current copy, please visit McElroy's website at [www.mcelroymetal.com](http://www.mcelroymetal.com).

# MEDALLION II

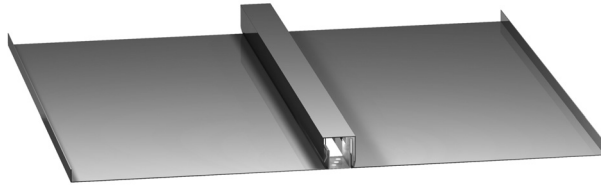

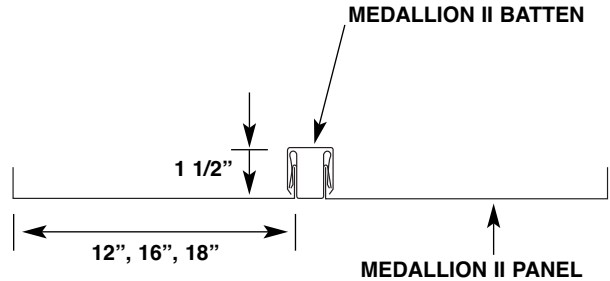

**Medallion II**

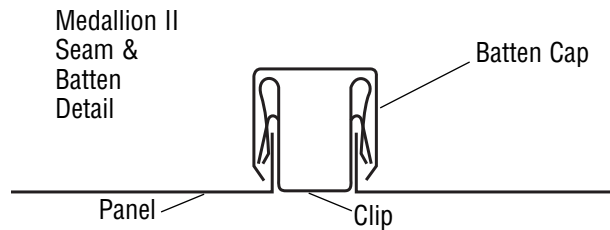

Cover width is pan width plus 1".

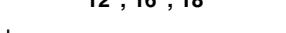
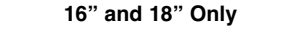

## Medallion II Pan Conditions

MEDALLION II STRIATED*	
	12", 16", 18"
MEDALLION II FLAT PAN	
	12", 16", 18"
MEDALLION II DOUBLE PENCIL RIBS	
	16" and 18" Only
MEDALLION II SINGLE PENCIL RIB	
*Recommended Pan Condition	12" Only

For any available Testing Data, Section Properties, or Load Tables, please visit [www.mcelroymetal.com](http://www.mcelroymetal.com). For additional information, please contact the **McElroy Engineering Department at 1-800-950-9082**.

### Details:

- Minimum slope: 3:12
- Must be installed over solid decking
- Curving: Medallion I only - minimum radius 30"
- Oil canning is a natural occurrence in metal panels and is not a cause for panel rejection

### Panel Options:

- Panel width: 12", 16", and 18"
- Panel configurations: striated, ribbed or flat pan (striated recommended)
- Coating:
  - Kynar 500® (PVDF)
- Substrate:
  - Standard 24 GA Galvalume®

### Notes:

- Please contact a McElroy representative for specific pricing, lead times, special colors or gauges that may not be on a McElroy Metal color chart.
- Contents in this manual are subject to change without notice. To confirm this book is the most current copy, please visit McElroy's website at [www.mcelroymetal.com](http://www.mcelroymetal.com).

# MEDALLION I

## TRIM

24 GA

**Soffit Base Trim  
MDSB**

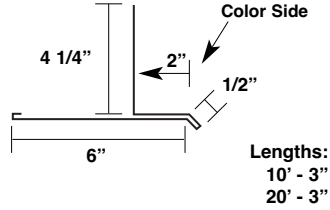

**Outside Corner  
MDOC**

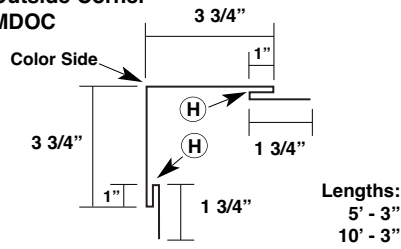

**Inside Corner  
MDIC**

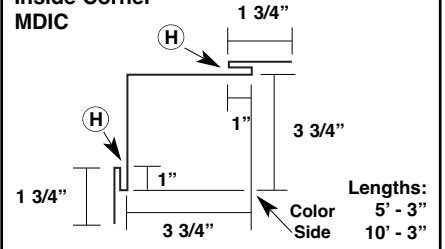

**Eave Trim\*  
MDET**

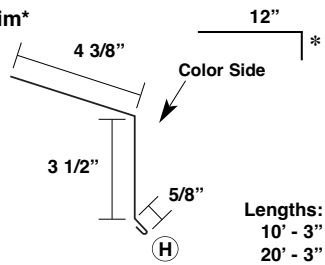

**Eave Drip/Rake Trim\*  
MDED1**

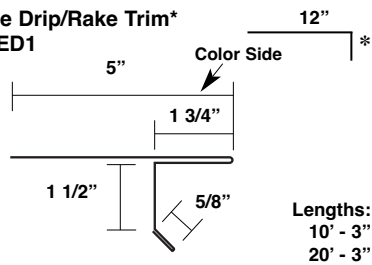

**Eave Drip/Rake Trim\*  
MDED3**

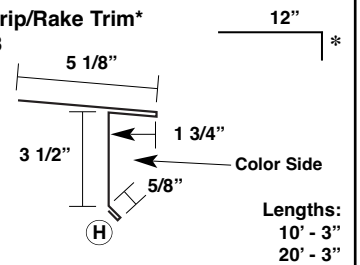

**Perimeter Cleat  
MDPC**

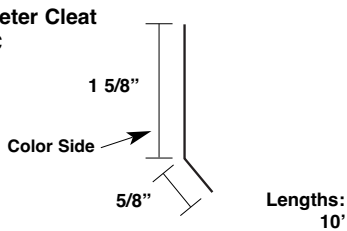

**Perimeter Zee Trim  
M1PZ**

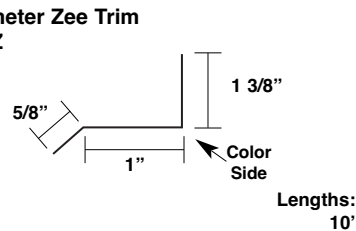

**Valley Trim\*  
MDVT**

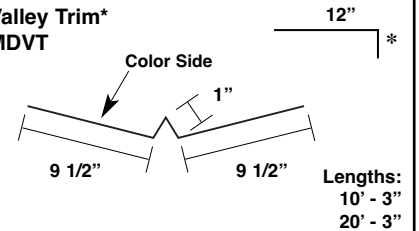

**Offset Cleat  
MDOF**

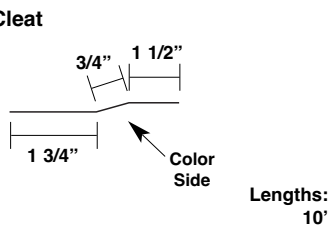

**Rake Trim  
M1RT**

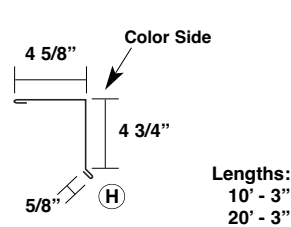

**Alternate Rake Trim  
MDAR**

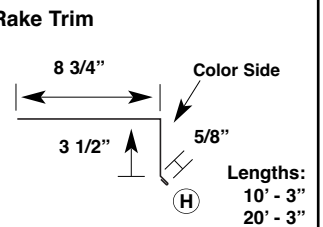

**Rake Tie-In Trim  
MDEW**

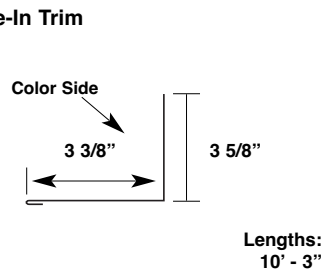

**Zee Closure  
M1ZC**

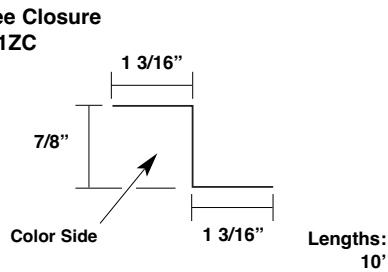

**High Side Trim\*  
M1HS**

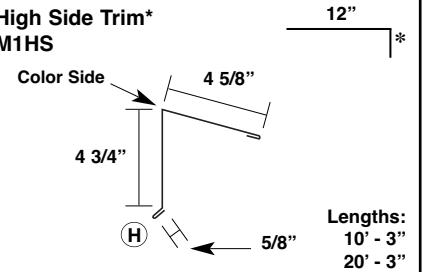

**High Side Tie-In Trim\*  
MDSW**

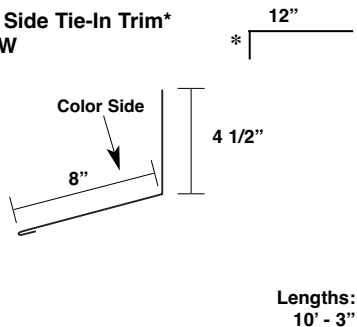

**Hip Flashing\*  
MDHF**

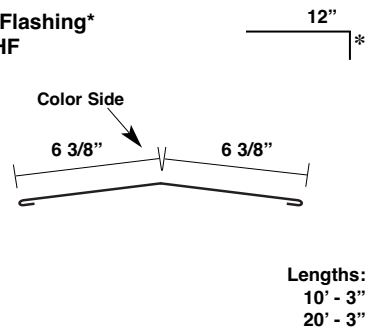

**Ridge Flashing\*  
MDRF**

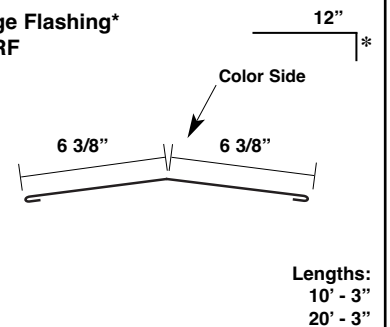

\*specify roof pitch

(H) Indicates an open hem - All other hems are closed.

# MEDALLION I

## TRIM

24 GA

**\*\*Face Mounted Gutter  
MDFMG**

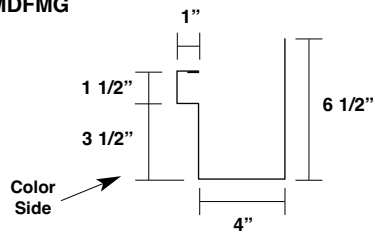

\*\*Snow guards required to prevent damage caused by sliding snow.

Lengths:  
10' - 3"  
20' - 3"

**\*\*Flanged Gutter\*  
MDFLG**

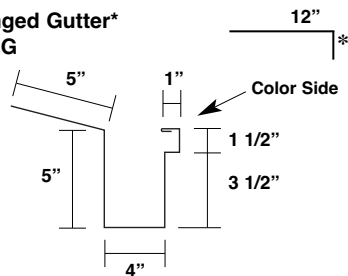

\*\*Snow guards required to prevent damage caused by sliding snow.

Lengths:  
10' - 3"  
20' - 3"

**Gutter Strap  
MD-GS**

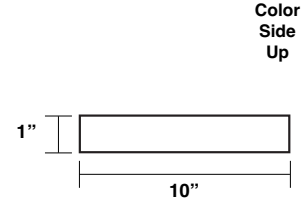

Color  
Side  
Up

Lengths:  
10"

**Gutter End Cap  
MDGECL (Left)  
MDGECR (Right)**

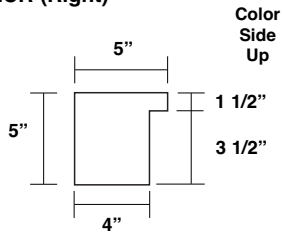

Color  
Side  
Up

26 Ga.

**Aluminium Downspout Outlet  
BBPOUT**

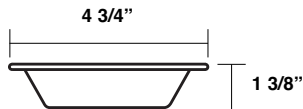

**Downspout 3" x 4"  
26 Ga. = BBPDS**



Lengths:  
14' - 3"

**Downspout Strap  
BBPDSS**

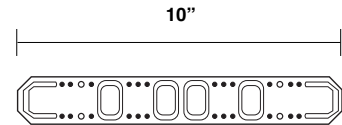

Lengths:  
10"

Only available in 26 Ga.

**3" x 4" Downspout Elbow A-Style  
26 Ga. = BBPELA**

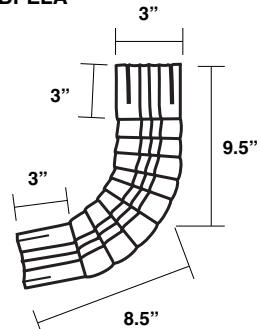

29 Ga. only available at the  
Marshall and Lewisport locations.

### Notes:

\*specify roof pitch

Ⓜ Indicates an open hem - All other hems are closed.

# MEDALLION II

## TRIM

24 GA

**Soffit Base Trim  
MDSB**

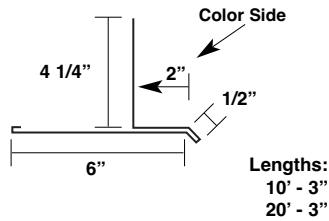

**Outside Corner  
MDOC**

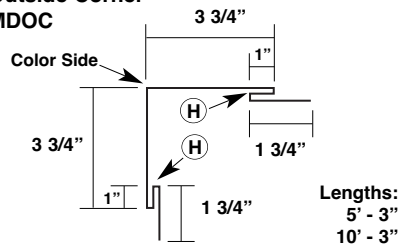

**Inside Corner  
MDIC**

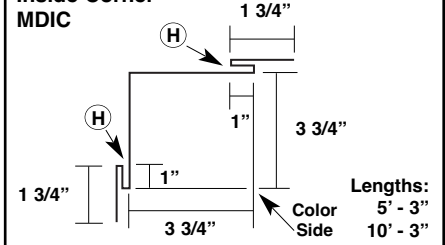

**Eave Trim\*  
MDET**

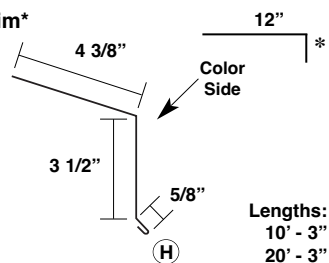

**Eave Drip/Rake Trim\*  
MDED1**

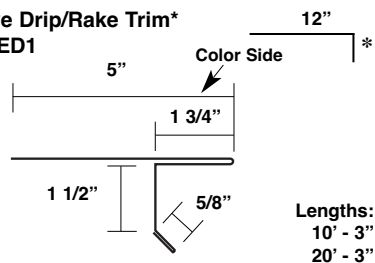

**Eave Drip/Rake Trim\*  
MDED3**

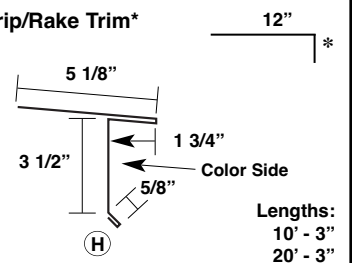

**Perimeter Cleat  
MDPC**

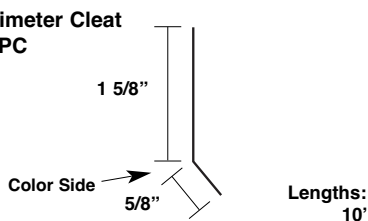

**Perimeter Zee Trim  
M2PZ**

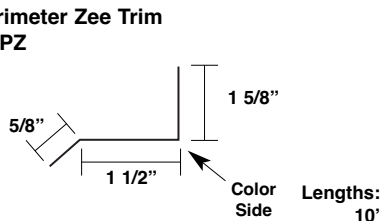

**Valley Trim\*  
MDVT**

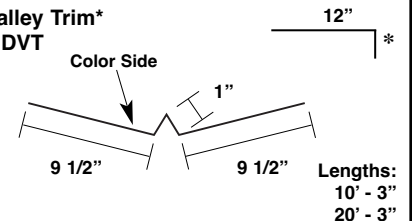

**Offset Cleat  
MDOF**

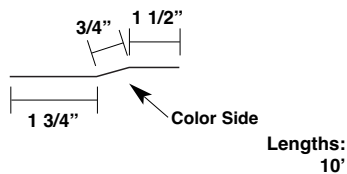

**Rake Trim  
M2RT**

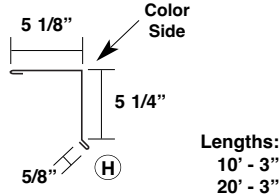

**Alternate Rake Trim  
MDAR**

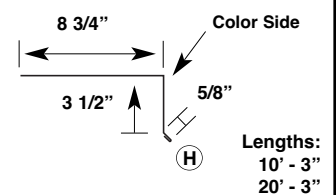

**Rake Tie-In Trim  
MDEW**

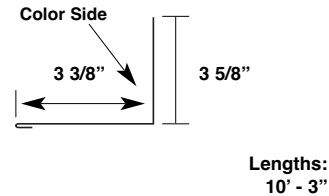

**Zee Closure  
M2ZC**

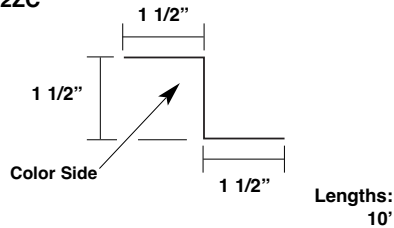

**High Side Trim\*  
M2HS**

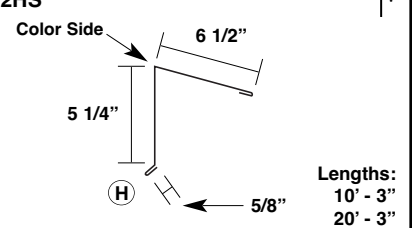

**High Side Tie-In Trim\*  
MDSW**

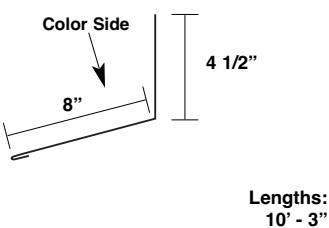

**Hip Flashing\*  
MDHF**

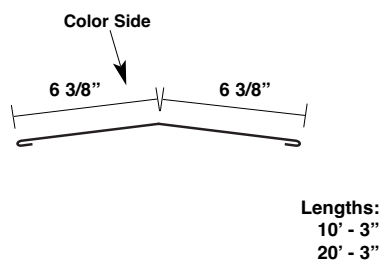

**Ridge Flashing\*  
MDRF**

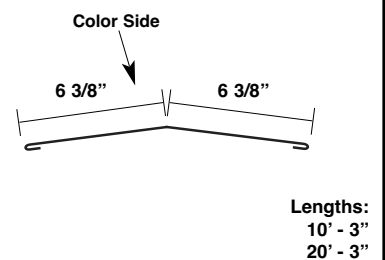

\*specify roof pitch

(H) Indicates an open hem - All other hems are closed.

# MEDALLION II

## TRIM

24 GA

**\*\*Face Mounted Gutter**  
MDFMG

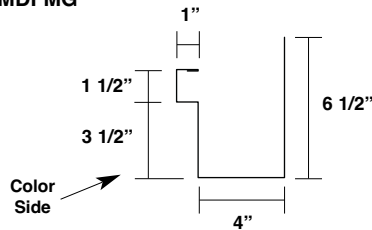

\*\*Snow guards required to prevent damage caused by sliding snow.

Lengths:  
10' - 3"  
20' - 3"

**\*\*Flanged Gutter\***  
MDFLG

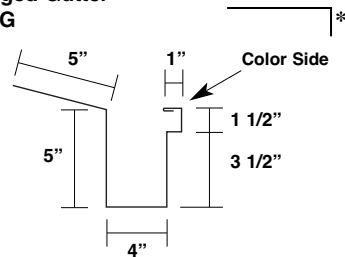

\*\*Snow guards required to prevent damage caused by sliding snow.

Lengths:  
10' - 3"  
20' - 3"

**Gutter Strap**  
MD-GS

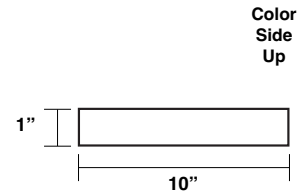

Lengths:  
10"

**Gutter End Cap**  
MDGECL (Left)  
MDGECR (Right)

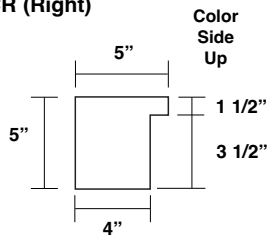

26 Ga.

**Downspout 3" x 4"**  
26 Ga. = BBPDS

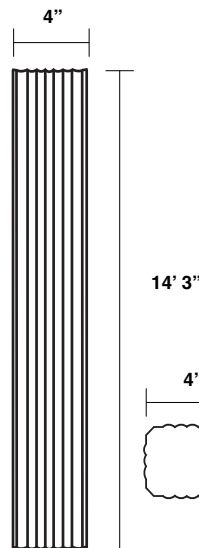

Lengths:  
14' - 3"

**Downspout Strap**  
BBPDSS

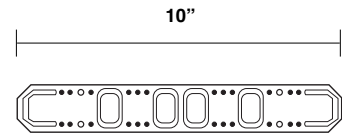

Lengths:  
10"

Only available in 26 Ga.

**Aluminum Downspout Outlet**  
BBPOUT

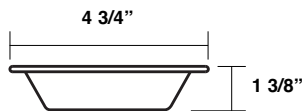

**3" x 4" Downspout Elbow A-Style**  
26 Ga. = BBPELA

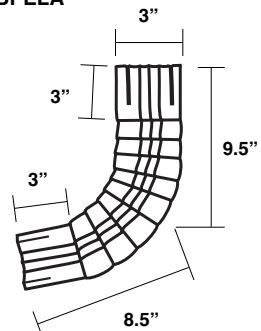

29 Ga. only available at the Marshall and Lewisport locations.

### Notes:



# MEDALLION I & II

## ACCESSORIES

26 GA

**Bearing Plate**  
 Item #: 94599 Primed  
 Item #: 203541 Galvanized

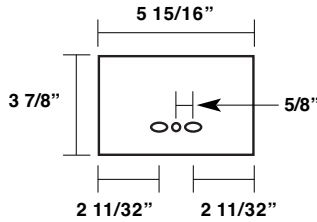

**#9 - 15 x 1" Woodgrip**  
 W/O Washer - Plain  
 Item #: 36115



**1/4 - 14 x 1 1/4" TEK 2**  
 W/O Washer - Plain  
 Item #: 10969



**#10 - 12 x 1" Type A**  
 Pancake Head  
 Woodgrip  
 Item #: 36116001



**#10 - 16 x 1" TEK2**  
 Pancake Head  
 Self-Driller  
 Item #: 36117



**1/4" - 14 x 7/8"**  
 LAPTEK ZAC  
 Self-Driller  
 (Part # Varies by Color)

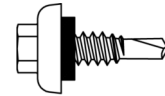

**43D Pop Rivets**  
 (Part # Varies by Color)

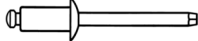

**Butyl Tape Sealant**  
 3/32" x 1" x 45'  
 Item #: 95335

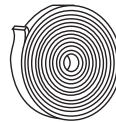

**Titebond Caulk Sealant**  
 (Part # varies by color)



**White Urethane Sealant**  
 Item #: 95320



**Sikalastomer Tube Sealant**  
 Item #: 95342



**Hemming Tool**  
 Item #: 36120

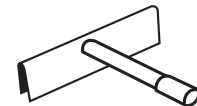

**Touch-Up Paint Pen**  
 (Part # Varies by Color)





# MEDALLION I BATTEN and CLIP

**BATTEN &  
CLIP**

26 GA

Medallion I Clip  
Item #: 36500

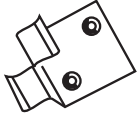

Medallion I Batten

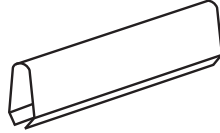

# MEDALLION II BATTEN and CLIP

**BATTEN &  
CLIP**

Medallion II Clip  
Item #: 36510

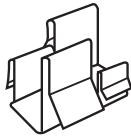

Medallion II Batten

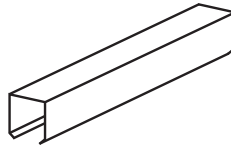

**Notes:**



# *MEDALLION I & II*

Notes:

A large, empty rectangular area intended for handwritten notes, framed by a thin black border.



☆ MANUFACTURING LOCATIONS ● SERVICE CENTERS ★ MANUFACTURING AND SERVICE CENTER



**CORPORATE OFFICE**  
1500 HAMILTON RD.  
BOSSIER CITY, LA 71111

**MANUFACTURING LOCATIONS**

ADELANTO, CA	ASHBURN, GA	BOSSIER CITY, LA	CLINTON, IL	DIAMOND, MO
HOUSTON, TX	LEWISPORT, KY	LOCKHART, TX	MARSHALL, MI	MAUSTON, WI
MERKEL, TX	PEACHTREE CITY, GA	SUNNYVALE, TX	WINCHESTER, VA	

**MCELROY METAL**  
**SERVICE**  
C E N T E R

17031 Koala Road Adelanto, CA 92301	5215 Leo St. Alexandria, LA 71301	1007 Wilso Dr, Baltimore, MD 21223	1500 Hamilton Rd. Bossier City, LA 71111
3052 Yadkin Road Chesapeake, VA 23323	9476 Meadowbrook Rd. Clinton, IL 61727	3215 Highway 59 Diamond, MO 64840	390 N. Valley Dell Dr. Fenton, MO 63026
409 Lovejoy Road Ft. Walton Beach, FL 32548	3014 Lincoln Court Garland, TX 75041	1440 Aldine Bender Road Houston, TX 77032	10504 E. 59th Street Indianapolis, IN 46236
32 Industrial Circle Lancaster, PA 17601	9435 US Hwy. 60 W. Lewisport, KY 42351	2701 Cahill Street Lockhart, TX 78644	1020 Veterans Street Mauston, WI 53948
5123 Terminal Dr. McFarland, WI 53558	514 Cave Road Nashville, TN 37210	8304 Hwy. 70 E. North Little Rock, AR 72117	613 North Bierdeman Rd. Pearl, MS 39208
8511 Industrial Drive Pearland, TX 77584	2755 Hwy 60 Pendergrass, GA 30567	7450 Tower Street Richland Hills, TX 76118	8200 Berry Ave. Suite 100 Sacramento, CA 95828
1365 Dean Forest Rd. Savannah, GA 31405	7355 Oakley Industrial Blvd. Union City, GA 30291	1144 Silstar Rd. West Columbia, SC 29170	325 McGhee Rd. Winchester, VA 22603

Website: [www.mcelroymetal.com](http://www.mcelroymetal.com) • E-mail: [info@mcelroymetal.com](mailto:info@mcelroymetal.com)