

# MEDALLION-LOK

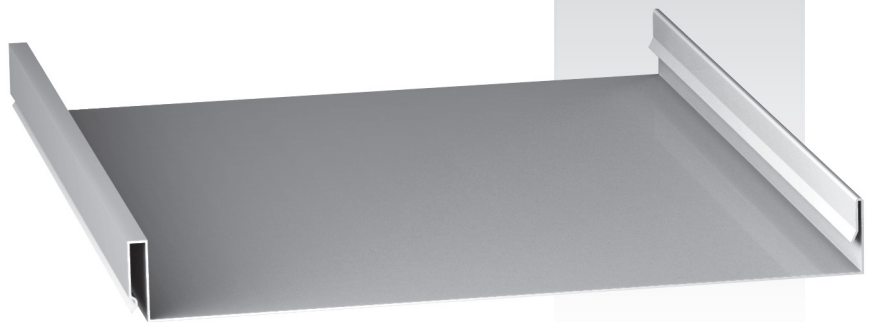

Panel / Trim / Accessories



# MEDALLION-LOK

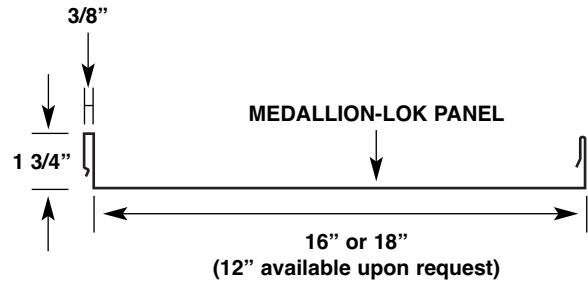
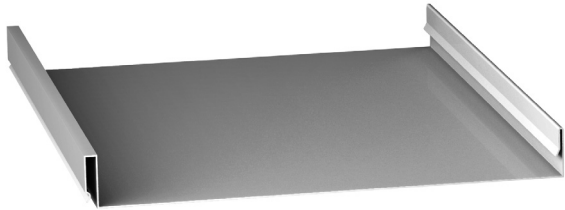

## Medallion-Lok

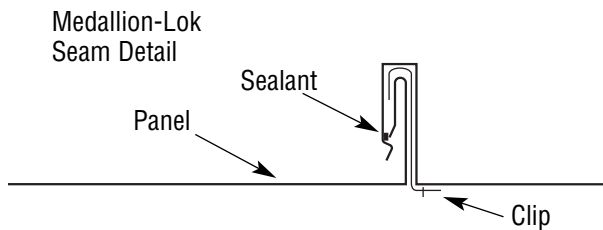

## Pan Conditions

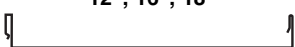
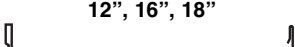
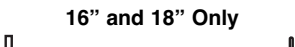
MEDALLION-LOK STRIATED*	
	12", 16", 18"
MEDALLION-LOK FLAT PAN	
	12", 16", 18"
MEDALLION-LOK DOUBLE PENCIL RIBS	
	16" and 18" Only
MEDALLION-LOK SINGLE PENCIL RIB	
	12" Only

\*Recommended Pan Condition

## Medallion-Lok Load Tables and Section Properties

For any available Testing Data, Section Properties, or Load Tables, please visit [www.mcelroymetal.com](http://www.mcelroymetal.com). For additional information, please contact the **McElroy Engineering Department at 1-800-950-9082**.

### Details:

- Factory formed eave notch upon request in:  
Clinton, Peachtree City, and Sunnyvale
- Factory applied sealant
- Minimum slope: 3:12
- Can be installed over solid deck or open framing
- Oil canning is a natural occurrence in metal panels and is not a cause for panel rejection

### Panel Options:

- Panel width: 12", 16", and 18"
- Panel configurations: striated, ribbed or flat pan (striated recommended)
- Coating:
  - Kynar 500® (PVDF)
- Substrate:
  - Standard 24 GA Galvalume®
  - Optional 22 GA Galvalume
  - Optional .032 aluminum

# MEDALLION-LOK

## TRIM

24 GA

**Soffit Base Trim  
MDSB**

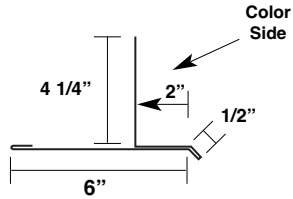

Lengths:  
10' - 3"  
20' - 3"

**Outside Corner  
MDOC**

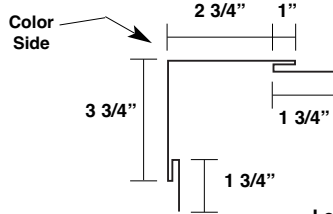

Lengths:  
5' - 3"  
10' - 3"

**Inside Corner  
MDIC**

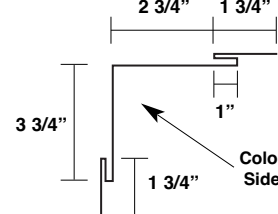

Lengths:  
5' - 3"  
10' - 3"

**Eave Trim\*  
MDET**

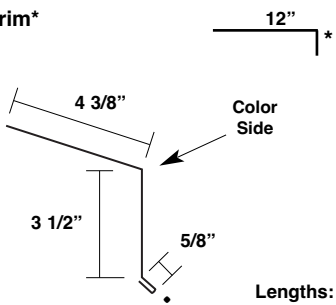

Lengths:  
10' - 3"  
20' - 3"

**Eave Drip / Rake  
1 1/2" Leg\*  
MDED1**

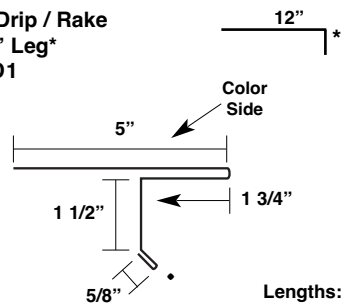

Lengths:  
10' - 3"  
20' - 3"

**Eave Drip / Rake  
3 1/2" Leg\*  
MDED3**

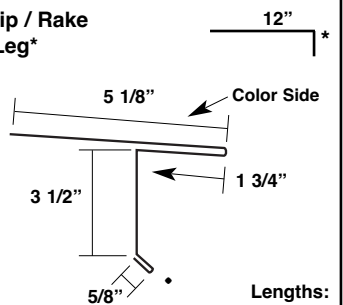

Lengths:  
10' - 3"  
20' - 3"

**Perimeter Cleat  
MDPC**

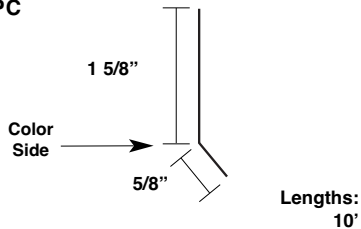

Lengths:  
10'

**Perimeter Zee Trim  
MDLPZ**

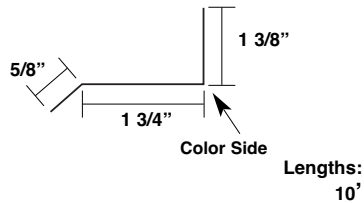

Lengths:  
10'

**Valley Trim\*  
MDVT**

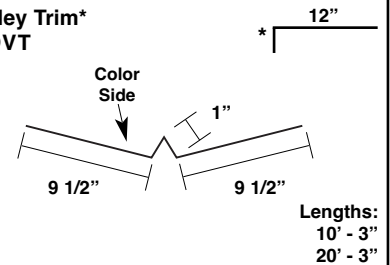

Lengths:  
10' - 3"  
20' - 3"

**Offset Cleat  
MDOF**

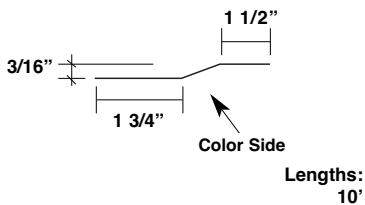

Lengths:  
10'

**Angle Trim  
MDAN**

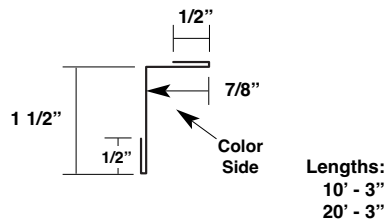

Lengths:  
10' - 3"  
20' - 3"

**Rake Trim  
MDLRT**

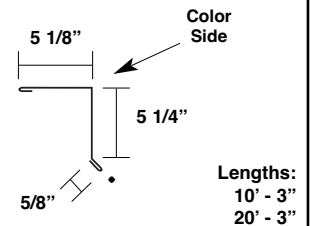

Lengths:  
10' - 3"  
20' - 3"

**Rake Tie-In Trim  
MDEW**

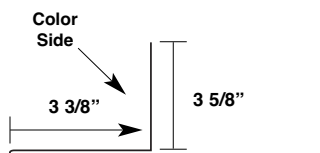

Lengths:  
10' - 3"  
20' - 3"

**Zee Closure  
MDLZC**

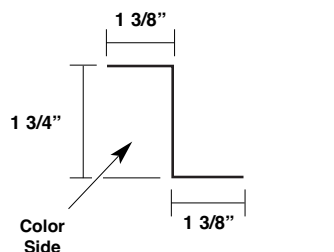

Lengths:  
10'

**Vented Zee Closure**

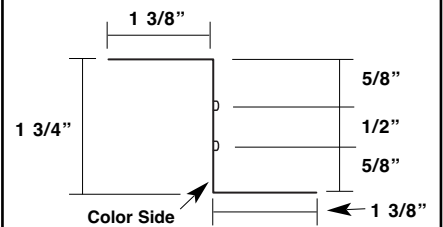

Produced in Peachtree City, GA plant only.  
Not to be used if weathertightness warranty is required. Lengths:  
20' - 3"

\*specify roof pitch

• Indicates an open hem - All other hems are closed.

# MEDALLION-LOK

## TRIM

**Hi-Side Trim\***  
MDLHS

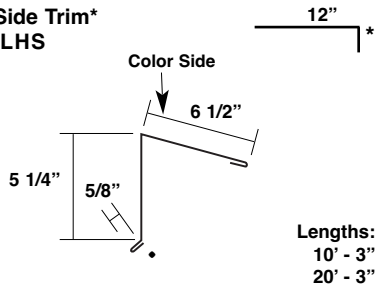

**Hi-Side Tie-In Trim\***  
MDSW

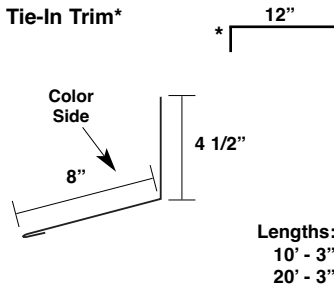

**Hip Flashing\***  
MDHF

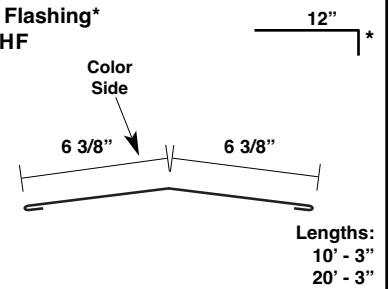

**Ridge Flashing\***  
MDRF

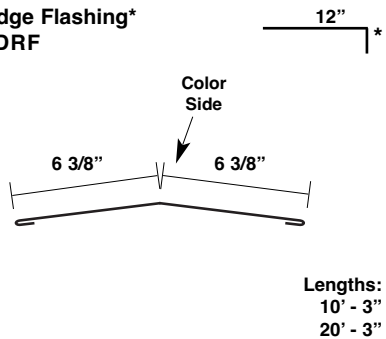

**\*\*Face Mounted Gutter**  
MDFMG

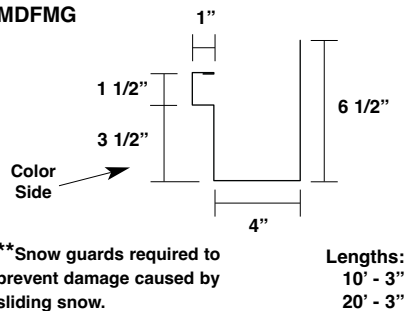

**\*\*Flanged Gutter\***  
MDFLG

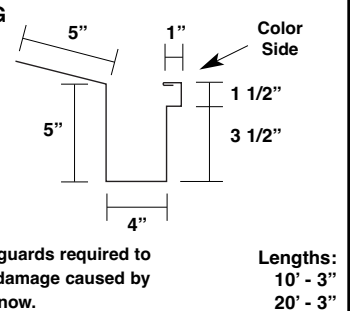

**Gutter Strap**  
MDGS

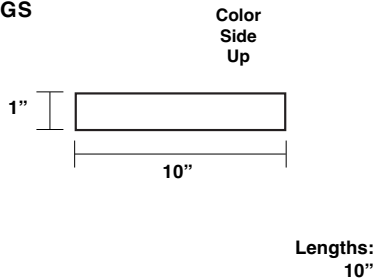

**Gutter End Cap**  
MDGECL (Left)  
MDGECR (Right)

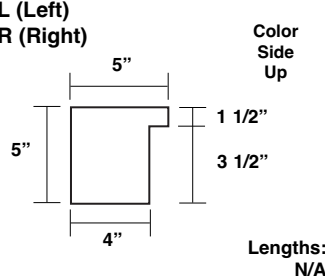

**Downspout**  
BBPDS

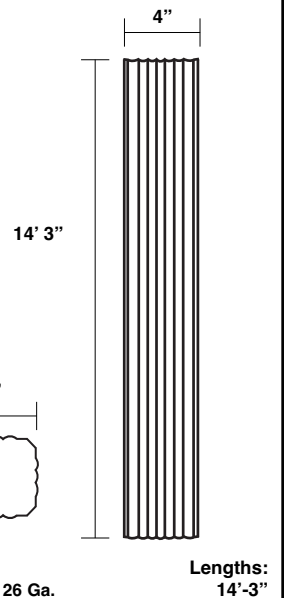

**Aluminum Downspout**  
**Outlet Box**  
BBPOUT

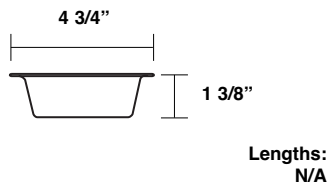

**Downspout Strap**  
BBPDSS

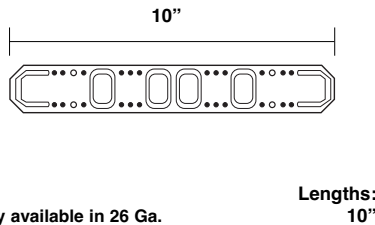

**3\"/>**

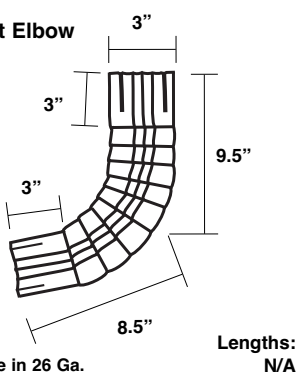

Only available in 26 Ga.

\*specify roof pitch

· Indicates an open hem - All other hems are closed.

# MEDALLION-LOK

## ACCESSORIES

Medallion-Lok  
Standard Clip  
Item #: 36512

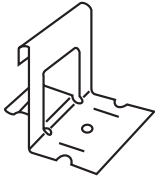

Medallion-Lok  
UL-90 Clip  
Item #: 36515

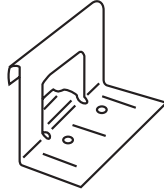

Utility Eave Plate  
Item #: 17477 Primed  
Item #: 221025 Galvanized

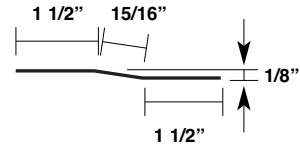

Lengths:  
10'

Bearing Plate  
Item #: 94599 Primed  
Item #: 203541 Galvanized

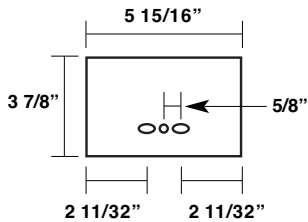

#9 - 15 x 1" Type A  
Woodgrip  
W/O Washer - Plain  
Item #: 36115



1/4 - 14 x 1 1/4" TEK2  
Self Driller  
W/O Washer - Plain  
Item #: 10969



#10 - 12 x 1" Type A  
Pancake Head  
Woodgrip  
Item #: 36116001



#10 - 16 x 1" TEK2  
Pancake Head  
Self-Driller  
Item #: 36117

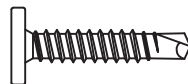

1/4 - 14 x 7/8" LAPTEK ZAC  
Self Driller  
(Part # Varies by Color)

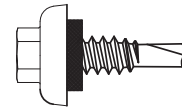

#14 - 10 DEKFAST Philips  
(Length Varies by Application)



43D PopRivets  
(Part # Varies by Color)

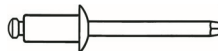

Roll Tape Sealant  
3/32" x 1" x 45'  
Item #: 95335

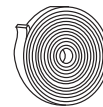

Titebond Caulk Sealant  
(Part # varies by color.)



White Urethane Sealant  
Item #: 95320



Butyl Tube Sealant  
Item #: 95342



# MEDALLION-LOK

## ACCESSORIES

Touch-Up Paint Pen  
(Part # Varies by Color)



Hemming Tool  
Item #: 36120

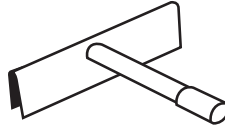

Notes:

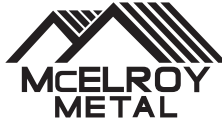

☆ MANUFACTURING LOCATIONS ● SERVICE CENTERS ★ MANUFACTURING AND SERVICE CENTER



**CORPORATE OFFICE**  
1500 HAMILTON RD.  
BOSSIER CITY, LA 71111

**MANUFACTURING LOCATIONS**

- |              |                    |                  |                |             |
|--------------|--------------------|------------------|----------------|-------------|
| ADELANTO, CA | ASHBURN, GA        | BOSSIER CITY, LA | CLINTON, IL    | DIAMOND, MO |
| HOUSTON, TX  | LEWISPORT, KY      | MARSHALL, MI     | MAUSTON, WI    | MERKEL, TX  |
|              | PEACHTREE CITY, GA | SUNNYVALE, TX    | WINCHESTER, VA |             |

**MCELROY METAL**  
**SERVICE**  
C E N T E R

- |  |  |   |  |
|--|--|---|--|
| 17031 Koala Road<br>Adelanto, CA 92301               | 5215 Leo St.<br>Alexandria, LA 71301           | 1007 Wilso Dr,<br>Baltimore, MD 21223             | 1500 Hamilton Rd.<br>Bossier City, LA 71111    |
| 3052 Yadkin Road<br>Chesapeake, VA 23323             | 9476 Meadowbrook Rd.<br>Clinton, IL 61727      | 3215 Highway 59<br>Diamond, MO 64840              | 390 N. Valley Dell Dr.<br>Fenton, MO 63026     |
| 409 Lovejoy Road<br>Ft. Walton Beach, FL 32548       | 3014 Lincoln Court<br>Garland, TX 75041        | 1440 Aldine Bender Road<br>Houston, TX 77032      | 10504 E. 59th Street<br>Indianapolis, IN 46236 |
| 32 Industrial Circle<br>Lancaster, PA 17601          | 9435 US Hwy. 60 W.<br>Lewisport, KY 42351      | 1020 Veterans Street<br>Mauston, WI 53948         | 5123 Terminal Dr.<br>McFarland, WI 53558       |
| 514 Cave Road<br>Nashville, TN 37210                 | 8304 Hwy. 70 E.<br>North Little Rock, AR 72117 | 613 North Bierdeman Rd.<br>Pearl, MS 39208        | 8511 Industrial Drive<br>Pearland, TX 77584    |
| 2755 Hwy 60<br>Pendergrass, GA 30567                 | 7450 Tower Street<br>Richland Hills, TX 76118  | 8200 Berry Ave. Suite 100<br>Sacramento, CA 95828 | 1365 Dean Forest Rd.<br>Savannah, GA 31405     |
| 7355 Oakley Industrial Blvd.<br>Union City, GA 30291 | 1144 Silstar Rd.<br>West Columbia, SC 29170    | 325 McGhee Rd.<br>Winchester, VA 22603            |  |

Website: [www.mcelroymetal.com](http://www.mcelroymetal.com) • E-mail: [info@mcelroymetal.com](mailto:info@mcelroymetal.com)