

# MASTERLOK-FS MASTERLOK-90

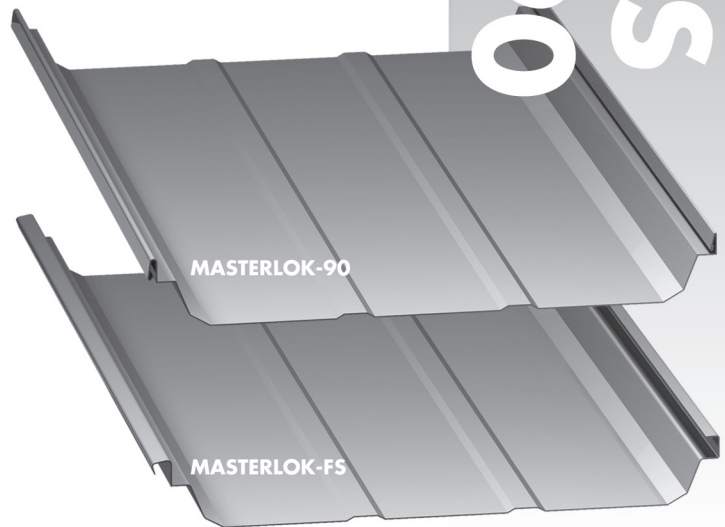

## Panel/Trim /Accessories





# MASTERLOK-90/FS

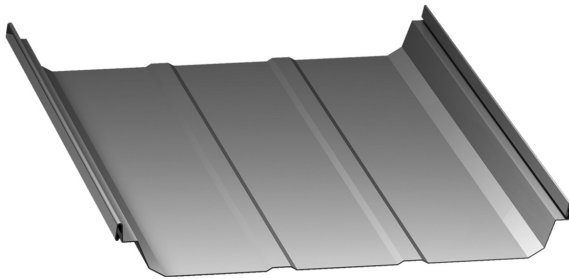

**MasterLok-90**

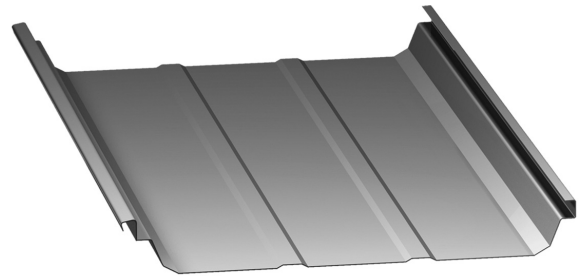

**MasterLok-FS**

MASTERLOK-90 PANEL

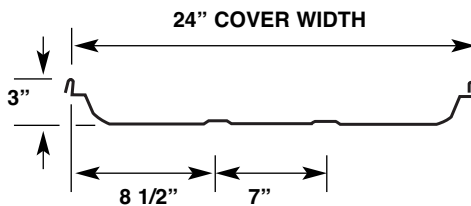

MASTERLOK-FS PANEL

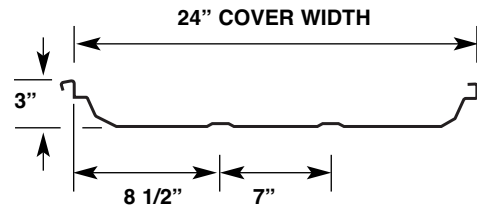

## MasterLok-90 / MasterLok-FS Load Tables and Section Properties

Load tables and section properties for MasterLok-90 and MasterLok-FS can be found online at [www.mcelroymetal.com](http://www.mcelroymetal.com). Please contact the **McElroy Engineering Department at 1-800-950-9082** for additional information.

### Details:

- Factory applied sealant in seam to improve weather-tightness
- Minimum Slope: 1/4:12
- Can be installed over solid deck or open framing
- MasterLok-FS is a mechanically seamed profile
- MasterLok-90 also available with MoistureLok

### Panel Options:

- Panel width: 24"
- Coating:
  - Kynar 500® (PVDF)
- Substrate:
  - Standard 24 GA Galvalume®
  - Optional 22 GA Galvalume

### Notes:

- Oil canning is inherent in all metal panels and is not cause for panel rejection.
- Please contact a McElroy representative for specific pricing, lead times, special colors or gauges that may not be on a McElroy Metal color chart.
- Contents in this manual are subject to change without notice. To confirm this book is the most current copy, please visit McElroy's website at [www.mcelroymetal.com](http://www.mcelroymetal.com).

# MASTERLOK-90/FS

## TRIM

24 GA

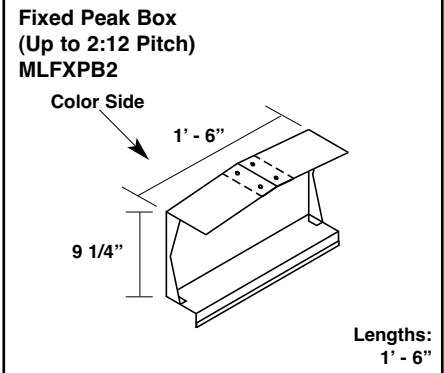
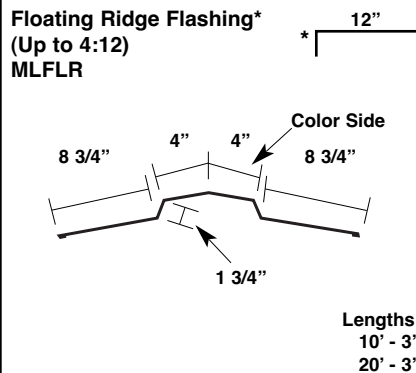
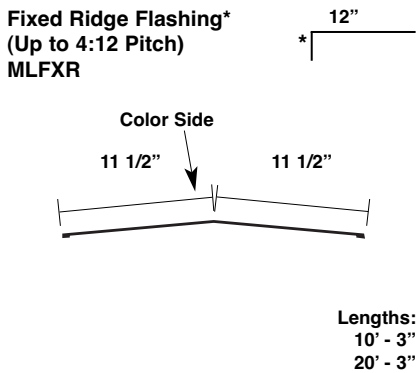
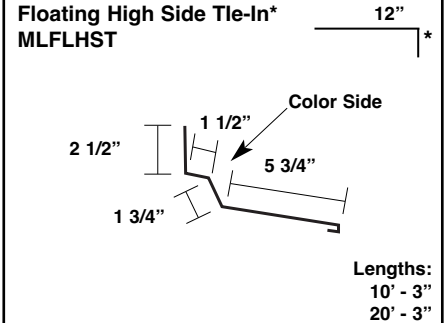
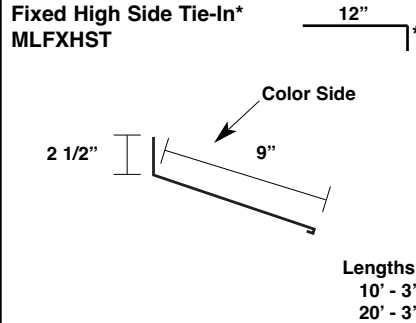
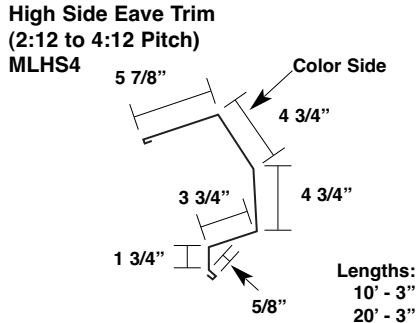
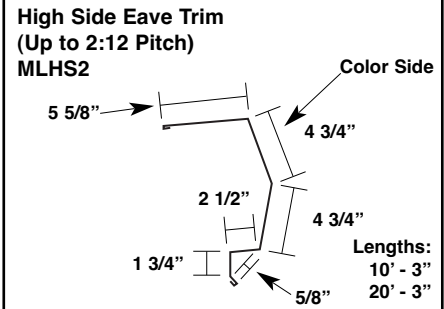
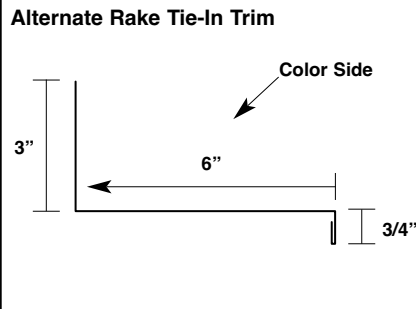
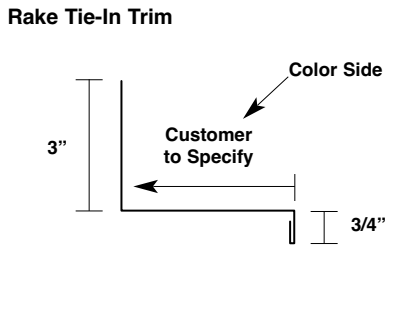
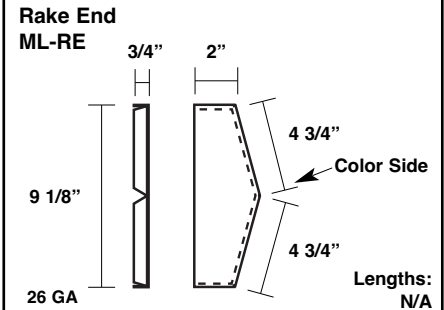
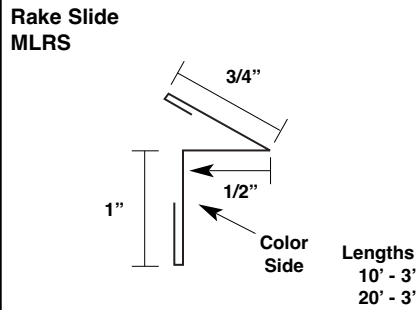
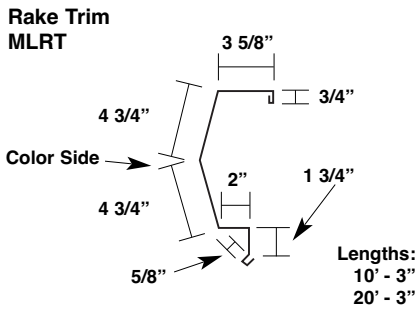
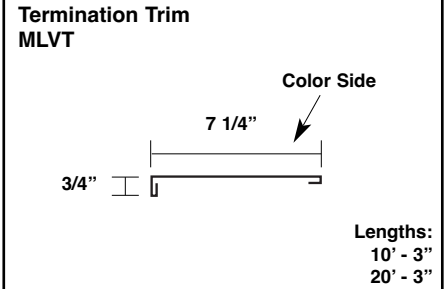
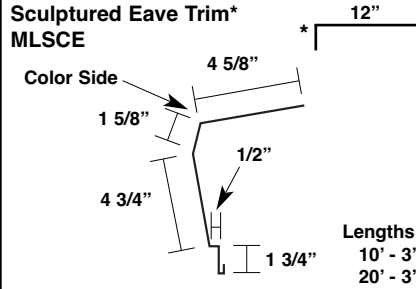
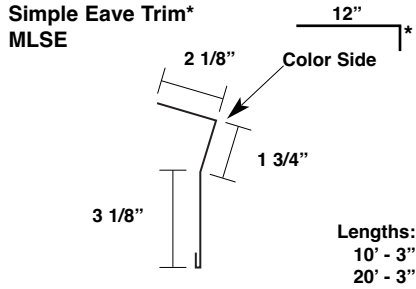

\*specify roof pitch

\* Indicates an open hem - All other hems are closed.

# MASTERLOK-90/FS

## TRIM

24 GA

**Fixed Peak Box**  
(2:12 to 4:12 Pitch)  
MLFXPB4

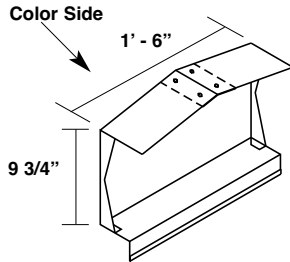

Lengths:  
1' - 6"

**Floating Peak Box**  
(Up to 2:12 Pitch)  
MLFLPB2

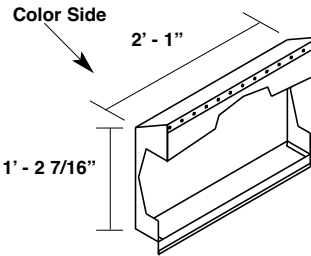

Lengths:  
2' - 1"

**Floating Peak Box**  
(2:12 to 4:12 Pitch)  
MLFLPB4

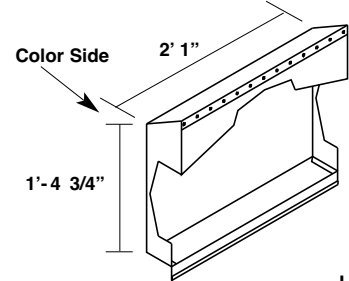

Lengths:  
2' - 1"

**Gutter**  
(Up to 2:12 Pitch)  
MLG2

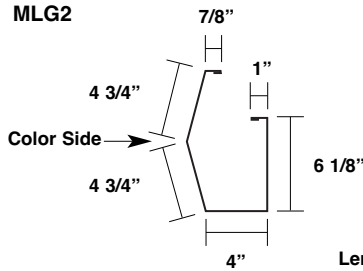

Lengths:  
10' - 3"  
20' - 3"

**Gutter**  
(2:12 to 4:12 Pitch)  
MLG4

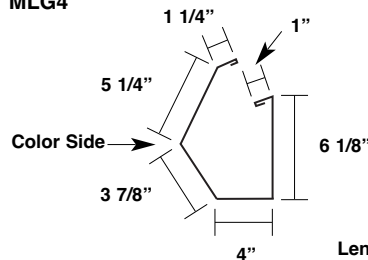

Lengths:  
10' - 3"  
20' - 3"

**Gutter Strap**  
ML-GS

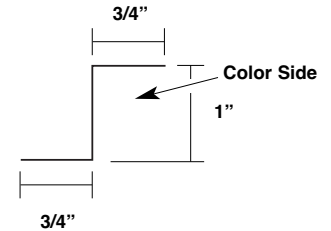

Lengths:  
0' - 6"

**Gutter End Cap**  
(Up to 2:12 Pitch)  
MLGE2

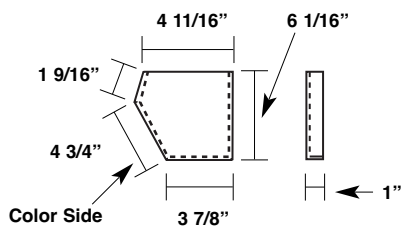

26 GA

Lengths:  
N/A

**Gutter End Cap**  
(2:12 to 4:12 Pitch)  
MLGE4

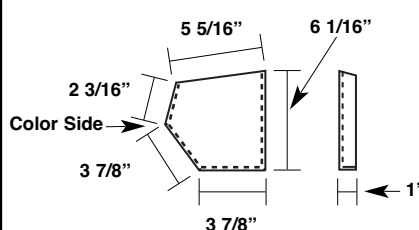

26 GA

Lengths:  
N/A

**Outside Corner Box for Standard Gutter**  
(Up to 2:12 Pitch)  
(Right Hand Shown - Left Hand Opposite)  
MLOCB

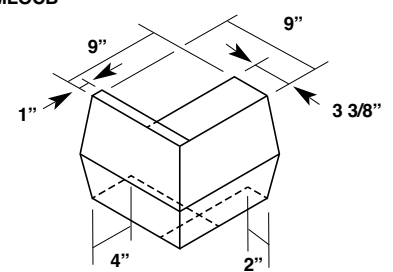

26 GA

Lengths:  
N/A

**Gutter Corner Box for Standard Gutter**  
(2:12 to 4:12 pitch or with Sculptured Gutter)  
(Right Hand Shown-Left Hand Opposite)

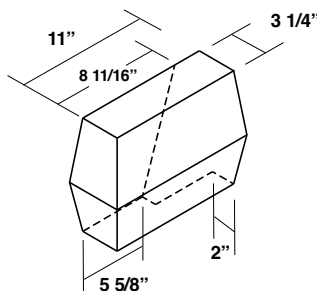

26 GA

Lengths:  
N/A

**Gutter Corner Box for Sculptured Eave**  
(Up to 4:12 Pitch)  
(Right Hand Shown-Left Hand Opposite)

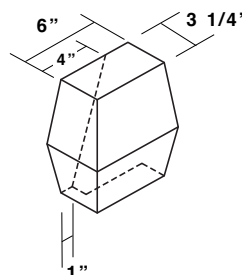

26 GA

Lengths:  
N/A

**High Side Corner Box**  
(Right Hand Shown-Left Hand Opposite)  
MLHCB

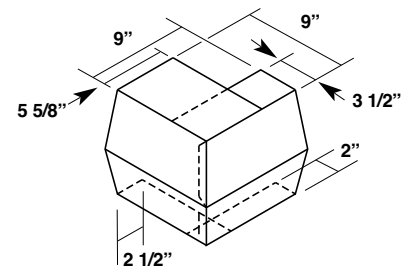

26 GA

Lengths:  
N/A

# MASTERLOK-90/FS

26 GA

**Cinch Angle  
ML-CA**

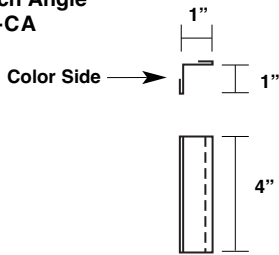

26 Ga.

Lengths:  
0' - 4"

**High-Low Tie-In Trim\*  
MLHL**

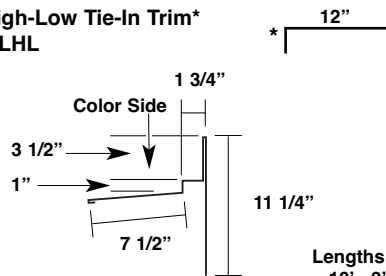

Lengths:  
10' - 3"  
20' - 3"

**Zee Flashing  
ML3ZF**

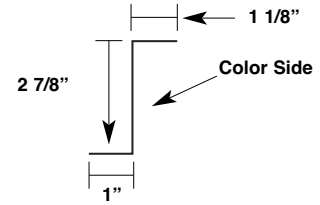

Lengths:  
10' - 3"

**Insulation Angle Trim  
MLIA**

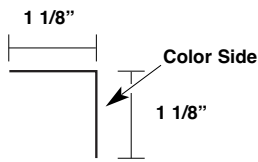

Lengths:  
10' - 3"

**Insulation Zee Trim  
MLIZ**

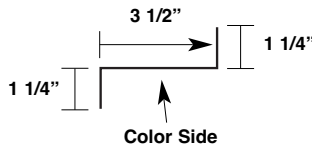

Lengths:  
2' - 0"

**Aluminum Downspout Outlet Box  
BBPOUT**

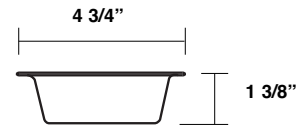

Lengths:  
N/A

**3" x 4" Downspout  
BBPDS**

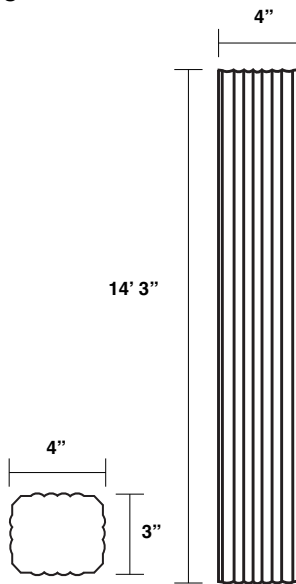

Lengths:  
14' - 3"

**Downspout Strap  
BBPDS**

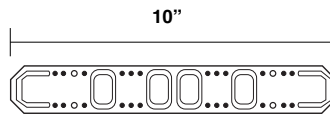

Lengths:  
10"

**3" x 4" Downspout Elbow  
A-Style  
BBPELA**

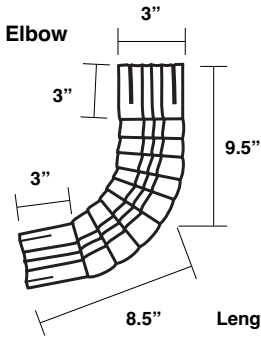

Lengths:  
N/A

**Lock-Seam Downspout - Corner  
(Right Hand Corner Shown)**

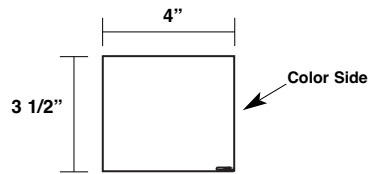

Please specify left or right hand corner

**Lock-Seam Downspout - Center**

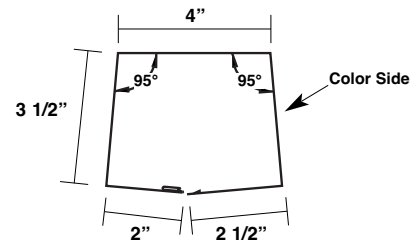

**Lock-Seam Downspout Outlet -  
Standard**

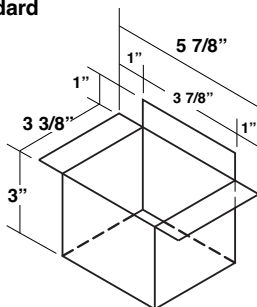

**Lock-Seam Downspout Strap**

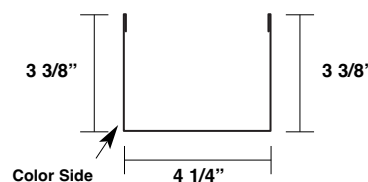

\*specify roof pitch

# MASTERLOK-90/FS

## ACCESSORIES

1/4 - 14 x 1 1/4"

TEK2  
Self Driller  
W/O Washer - Plain  
Item #: 10969

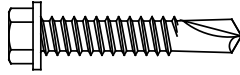

#12 - 24 x 1 1/4"

TEK 4.5  
W/O Washer - Plain  
Item #: 10979

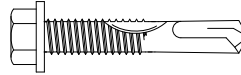

1/4 - 14 x 1 1/4"

Shoulder TEK2 3/8  
HWH W/O Washer - Plain  
Item #: 10975

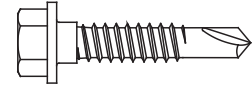

1/4 - 14 x 1 1/4"

TEK2 ZAC  
(Part # varies by color)

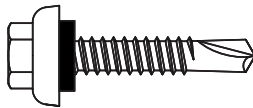

1/4 - 14 x 7/8"

LAPTEK ZAC  
Self Driller  
(Part # varies by color)

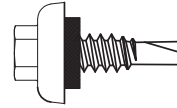

#14-10 Dekfast Pan Head  
(Length varies by application)



43D Pop Rivet  
(Part # varies by color.)



ML-90 Utility Fixed Clip  
Item #: 10919

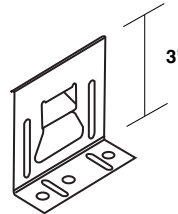

ML-90 Low Fixed Clip  
Item #: 10921

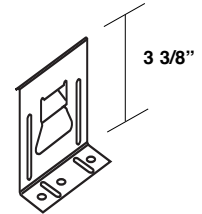

ML-90 High Fixed Clip  
Item #: 10922

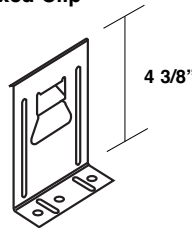

ML-90 Utility Floating Clip  
Item #: 10920

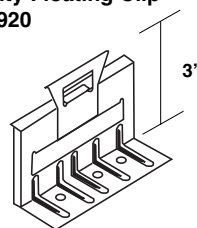

ML-90 Low Floating Clip  
Item #: 10923

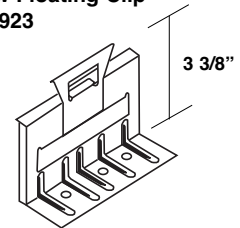

ML-90 High Floating Clip  
Item #: 10924

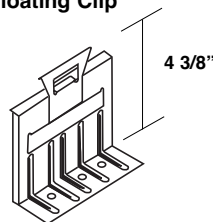

ML-FS Utility Floating Clip  
Item #: 10210

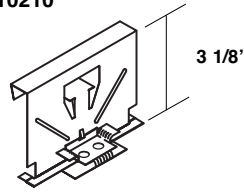

ML-FS Low Floating Clip  
Item #: 10211

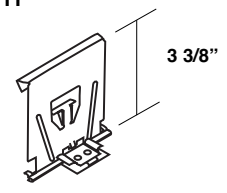

ML-FS High Floating Clip  
Item #: 10212

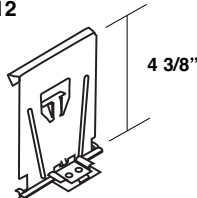

ML-FS 5" Floating Clip with  
2" Stand Off "2 Hole"  
Item #: 227329

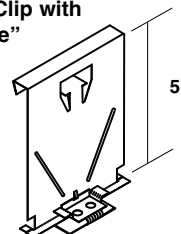

ML-FS 5" Floating Clip  
with 2" Stand Off "4 Hole"  
Item #: 235748

This clip is a non-stock item and will require longer lead times for delivery.

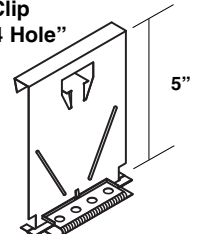

# MASTERLOK-90/FS

## ACCESSORIES

**Utility Eave Plate**  
Item #: 17477 Primed  
Item #: 221025 Galvanized

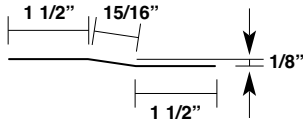

Lengths:  
10'

**Low Eave Plate**  
Item #: 10936 Primed  
Item #: 224381 Galvanized

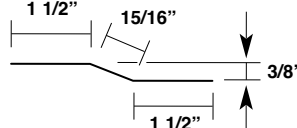

Lengths:  
10'

**High Eave Plate 14 GA**  
Item #: 17479 Primed

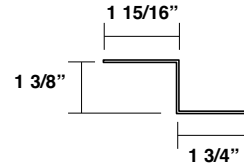

**High Eave Plate 16 GA**  
Item #: 10939 Primed  
Item #: 204132 Galvanized

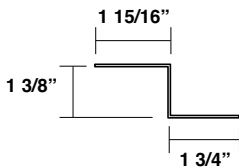

16 Ga.

**Utility Fixed Rake Support Angle**  
Primed  
10' Item #: 11213  
20' Item #: 11196

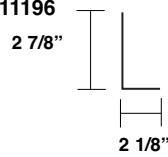

Lengths:  
10'  
20'

**Low Fixed Rake Support Angle**  
Primed  
10' Item #: 11005  
20' Item #: 10941

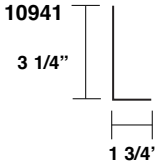

Lengths:  
10'  
20'

**High Fixed Rake Support Angle**  
Primed  
10' Item #: 11002  
20' Item #: 10943

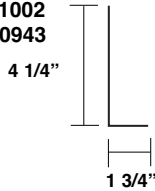

Lengths:  
10'  
20'

**Utility Floating Rake Support Angle**  
Primed  
Item #: 10942

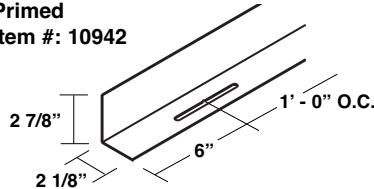

Lengths:  
10'

**Low Floating Rake Support Angle**  
Primed  
Item #: 10944

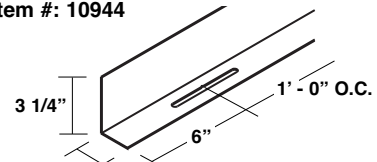

Lengths:  
10'

**High Floating Rake Support Angle**  
Primed  
Item #: 10946

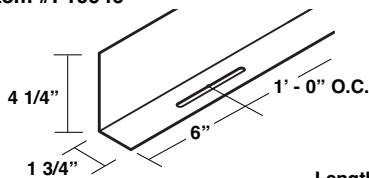

Lengths:  
10'

**MLFS Tall Floating Rake Support Angle**  
Primed  
Item #: 232319

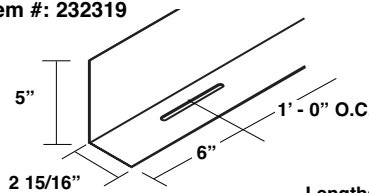

Lengths:  
10'

**MLFS Tall Eave Plate Primed**  
Item #: 232237

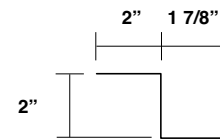

16 GA

Lengths:  
10'

**MLFS Tall Floating Rake Plate Primed**  
Item #: 232318

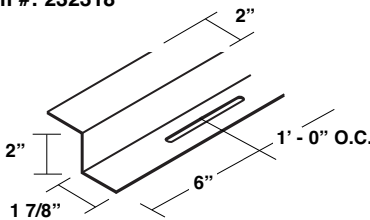

16 GA

Lengths:  
10'

**Floating Eave Plate Primed 2" Standoff**  
Item #: 232440

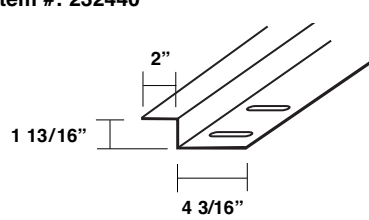

14 GA

Lengths:  
8'

**Bearing Plate**  
Item #: 94599 Primed  
Item #: 203541 Galvanized

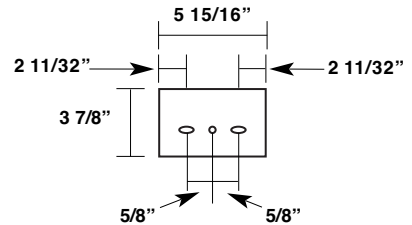

**Modified Back-Up Plate for 18" and 24" Utility Systems - Primed**  
18" Item #: 11206  
24" Item #: 10948

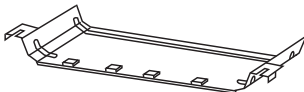

**Standard Back-Up Plate Primed**  
18" Item #: 10950  
24" Item #: 10949

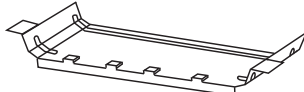

**Inside Closure - Metal**  
Item #: 10911  
(Available in bare only)





# MASTERLOK-90/FS

## ACCESSORIES

Inside Closure - Rubber  
Item #: 10957



Outside Closure  
(Part # varies by color)

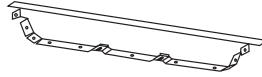

ML-90 Cinch Strap  
(Part # varies by color)

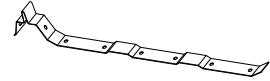

ML-FS Cinch Strap  
(Part # varies by color)

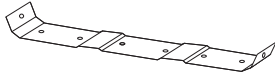

Butyl Tape Sealant - Double Bead  
3/16" x 7/8" x 40'  
Item #: 95460

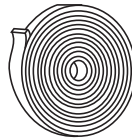

Butyl Tape Sealant  
1 1/2" x 1/8" x 30'  
Item #: 10959

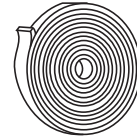

Butyl Tape Sealant  
3/32" x 1" x 45'  
Item #: 95335

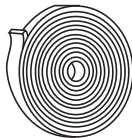

Strip Tape  
3/4" x 1 3/8" x 7/32" x 4"  
Item #: 95365

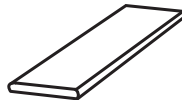

Titebond Caulk Sealant  
(Part # varies by color)



Sikalastomer Butyl Tube Sealant  
Item #: 95342



Thermal Spacer  
3/8" x 3" x 23 7/8" Item #: 11006  
5/8" x 3" x 23 7/8" Item #: 11008  
1" x 3" x 23 7/8" Item #: 10960  
1 3/8" x 3" x 23 7/8" Item #: 10961

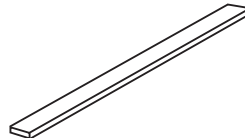

Touch-Up Paint Pen  
(Part # Varies by Color)



ML90 Seam Snapping Tool  
Item #: 10967



Unseaming Tool  
(ML-90 Only)  
Item #: 10966

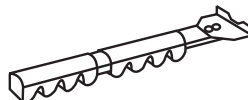



# *MASTERLOK-90/FS*

**NOTES:**





☆ MANUFACTURING LOCATIONS ● SERVICE CENTERS ★ MANUFACTURING AND SERVICE CENTER



**CORPORATE OFFICE**  
1500 HAMILTON RD.  
BOSSIER CITY, LA 71111

**MANUFACTURING LOCATIONS**

ADELANTO, CA	ASHBURN, GA	BOSSIER CITY, LA	CLINTON, IL	DIAMOND, MO
HOUSTON, TX	LEWISPORT, KY	MARSHALL, MI	MAUSTON, WI	MERKEL, TX
	PEACHTREE CITY, GA	SUNNYVALE, TX	WINCHESTER, VA	

**MCELROY METAL**  
**SERVICE**  
CENTER

17031 Koala Road Adelanto, CA 92301	5215 Leo St. Alexandria, LA 71301	1007 Wilso Dr, Baltimore, MD 21223	1500 Hamilton Rd. Bossier City, LA 71111
3052 Yadkin Road Chesapeake, VA 23323	9476 Meadowbrook Rd. Clinton, IL 61727	3215 Highway 59 Diamond, MO 64840	390 N. Valley Dell Dr. Fenton, MO 63026
409 Lovejoy Road Ft. Walton Beach, FL 32548	3014 Lincoln Court Garland, TX 75041	1440 Aldine Bender Road Houston, TX 77032	10504 E. 59th Street Indianapolis, IN 46236
9435 US Hwy. 60 W. Lewisport, KY 42351	1020 Veterans Street Mauston, WI 53948	5123 Terminal Dr. McFarland, WI 53558	514 Cave Road Nashville, TN 37210
8304 Hwy. 70 E. North Little Rock, AR 72117	613 North Bierdeman Rd. Pearl, MS 39208	8511 Industrial Drive Pearland, TX 77584	2755 Hwy 60 Pendergrass, GA 30567
7450 Tower Street Richland Hills, TX 76118	8200 Berry Ave. Suite 100 Sacramento, CA 95828	1365 Dean Forest Rd. Savannah, GA 31405	7355 Oakley Industrial Blvd. Union City, GA 30291
	1144 Silstar Rd. West Columbia, SC 29170	325 McGhee Rd. Winchester, VA 22603	

Website: [www.mcelroymetal.com](http://www.mcelroymetal.com) • E-mail: [info@mcelroymetal.com](mailto:info@mcelroymetal.com)